

Products & Parts Catalogue

Dudley 

Epson 

Beta 



The Plumbers Choice **Built for Plumbers. Built for Britain.**



Welcome to Thomas Dudley Plumbing Products

Thomas Dudley Plumbing Products brings together decades of engineering expertise to deliver an exceptional level of service, always placing our customers at the heart of what we do.

With a portfolio of over 6,000 dependable plumbing solutions - including WRAS Approved Dudley Syphons and Toilet Cisterns, high-quality Beta brassware, and Epsom washers and seals and Resan anti-ligature sanitaryware - we support installers, Merchants, and Specifiers across the UK and beyond.

Our capabilities have recently expanded even further with the acquisition of Bailey Products and its iconic Blue Rods®, strengthening our offering across drainage, telecoms, and chimney industries for both UK and international markets.

Our dedicated sales team is available via telephone, email, and in-person visits to support all sales and aftersales enquiries. For detailed product information, including datasheets, FAQs, and installation and maintenance videos, visit:

www.thomasdudley.co.uk



Free Delivery on orders over

£150

Carriage and Minimum Order Value

UK Shipping-excludes Highlands, some Scottish postcodes, Islands and Northern Ireland. Smaller orders subject to carriage charge.



Minimum Order Value

£35



British design,
British build,
Family business



Our brands

We combine the products and expertise across our six brands, Dudley, Epsom, Beta, Bailey products, Resan and Cronex to bring you a one-stop solution for your plumbing requirements. Each of our brands have been carefully designed to include a specific range of products allowing you to quickly and easily find the products you are looking for.

- One convenient, customer driven supplier
- Access to the Dudley, Epsom, Beta, Resan, Cronex & Bailey brands
- Over 6,000 innovative products
- Bespoke and own brand packaging formats
- One order, one invoice and one delivery
- Unrivalled UK stock holding and service
- Advanced warehousing and logistics
- Sales and Marketing support
- Dedicated technical helpline offering real-time installation support, troubleshooting and on-site visit arrangements
- On site UKAS accredited and WRAS recognised test facility



More than

6,000

trusted plumbing parts



Over

100

years experience



Dudley manufactures superior quality plumbing products in our dedicated and ultra-modern facilities here in the UK.



Quality doesn't have to cost the earth. Epsom supplies cost-effective solutions for a wealth of reliable plumbing parts.



Our plumbing brassware range, suitable for an array of plumbing jobs with excellence at the heart of each part.



Products designed for drainage, telecoms, and pipe testing industries



Cronex is our export range, distributing the best plumbing, hardware and electrical supplies worldwide.



We manufacture anti-ligature sanitaryware products for many market sectors.

contents

Innovations

01

Washroom fill & flush

- 22 **BUTTONS & PUSH PLATES**
- 30 **FRAMES**
- 35 **INLET VALVES**
- 40 **OUTLET VALVES**
- 42 **SYPHONS**

- 48 **TOILET CISTERNS**
CONCEALED CISTERNS
EXPOSED CISTERNS
AUTO CISTERNS
CISTERN OPTIONS
- 58 **TOUCH-FREE**
SOAP DISPENSERS
TAPS
URINAL CONTROLS
WC CONTROLS
ACCESSORIES

- 65 **RESAN
SANITARYWARE**
WC PANS & TOILETS
SINKS & BASINS
URINAL UNITS
MIRROR FRAMES & SHELVING
INTELLIGENT CONTROLS
OPTIONS

02

Plumbing Fittings & Spares

- 76 **BATHROOM
/ KITCHEN
ACCESSORIES**
WASTE, TRAPS &
ACCESSORIES
PAN CONNECTORS
TOILET SEATS
ACCESSORIES
GRAB RAILS
PLUGS & CHAINS
- 109 **CISTERN LEVERS
& PULLS**

- 118 **CISTERN TANK
FITTINGS**
SYPHON & FLUSHING
VALVE ACCESSORIES
FLUSHPIPE BENDS
& ACCESSORIES
CLOSE COUPLING
KITS & SPARES

- 123 **PRE-PACKED
PRODUCTS**
PLUMBING BOXES
POLY BAG RANGE

- 131 **WASHERS
AND SEALS**
TAP
TOILET CISTERN / TANK
TRAP & WASTE
CENTRAL HEATING
SERVICE & HOSE
GENERAL
O RINGS

03

Pipes, Valves & Fittings

- 138 **BRASS FLOAT VALVES
& ACCESSORIES**
- 144 **PLASTIC FLOATS**
- 145 **COMPRESSION
PIPE FITTINGS**
BRASS PIPE FITTINGS
CHROME PIPE FITTINGS
- 150 **THREADED PIPE
FITTINGS**

- 153 **CONSUMABLES**
- 154 **DRAINAGE
EQUIPMENT**
DRAIN RODS & ACCESSORIES
SEWER RETRIEVAL KIT
TELECOMS
TEST PLUGS
- 164 **GAS PRODUCTS**
- 166 **PIPE CLIPS**

- 170 **PLUMBING
BRASSWARE &
ACCESSORIES**
RADIATOR & HEATING
PRODUCTS
WASHING MACHINE
ACCESSORIES
VALVES
FLEXIBLE TAP CONNECTORS
- 185 **WATER HAMMER
ARRESTORS**

04

Spares

186

Thomas Dudley Limited was established in 1920

In 1936, Thomas Dudley sailed on the Queen Mary's maiden voyage to America and visited a number of foundries to help formulate his vision for the future of the company he set up in 1920.



1920

Mr Thomas Dudley set up his own Foundry, having previous experience managing foundries around the UK



1940-50

The Foundry grows rapidly and supports the war effort during World War 2



1971

Our purpose-built bathroom products factory opens and our first exposed plastic cistern is unveiled



1984

Leading the way Dudley Turbo 88, the first 2 piece syphon is launched



1995

We celebrate 75 years of success



1989

Masefield-Epson Ltd purchased by Thomas Dudley Ltd.



2008

1997. Ecosan Ltd is acquired by Thomas Dudley Ltd 2008, leading to our current Resan sanitaryware range.



2016

Cronexrabo export business is acquired by Thomas Dudley Ltd.



2025

Bailey Products business is acquired by Thomas Dudley Ltd. Expanding the range of products designed for drainage, telecoms and pipe testing industries.



The Foundry relocates to our current Head Office site in Dudley UK

1936

Black rubber WC cisterns provide the foundation to the bathroom products division

1950's

1961. Masefield Plastimetals Ltd was founded

1968. Epson Products Ltd acquired by Masefield Plastimetals

Masefield-Epson Ltd was formed

1972



Dudley Vantage, the first front access cistern, is launched

2003

2006. Beta Ballvalves acquired by Thomas Dudley Ltd.



Masefield-Epson Ltd and Beta Ballvalves merge to become Masefield-Beta Ltd.

2012



Thomas Dudley Plumbing Products is launched as we merge Thomas Dudley Ltd and Masefield Beta Ltd. and the company celebrates 100 years of success



2020

2024. Thomas Dudley Plumbing launches Quantum - the World's first push button syphon!





Built for Plumbers. Built for Britain.

Plumbers Choice brings together the best of British engineering, compliance, and real-world insight.

Every product is designed to save water, cut call-backs, and deliver the reliability professionals expect - backed by WRAS approval, UK manufacturing, and support that goes far beyond the box.

From precision-built, Made in Britain quality to our work with colleges,

ambassadors, and the wider trade, Plumbers Choice is shaped by the people who use it most. When plumbers choose our products, they're choosing confidence, compliance, and a brand committed to Britain's future.

Water Saving, Made in Britain, Compliant

WRAS APPROVAL & COMPLIANCY



Confidence Built Into Every Product

Tested to UK water regulations. Built to protect. Engineered to eliminate risk.

WRAS approved or compliance assured, giving plumbers faster installs, fewer call-backs, and total confidence on every job.

MADE IN BRITAIN



Quality You Can Fit and Forget

Crafted to the highest standards right here in the UK. Precision-built, reliable, and made with genuine pride.

Every product reflects the trust and quality of British manufacturing - giving plumbers confidence that what they fit is built to last.

SUPPORTING THE UK ECONOMY



Plumbers Backing Britain's Future.

Every product fuels the local economy - creating jobs, supporting communities, and championing British expertise.

By choosing our solutions, plumbers back people, strengthen communities, and support the future of UK manufacturing.

COLLEGE & SCHOOL PARTNERSHIP



Investing in the Future of the Trade

By partnering with plumbing colleges and schools, we help train the next generation and keep essential skills strong across the UK.

Every product comes from a company that understands the craft, values the trade, and is committed to sustaining it for years to come.

AMBASSADOR PROGRAMME



Built Around Real Plumber Needs

By working directly with real plumbers, we understand their pain points and design solutions that make life easier; one-box kits, easy van stock, leak-free installs, and water-saving products that cut call-backs.

Every product is shaped by the people who use it most.

TECHNICAL HELPLINE & SUPPORT



Support That Goes Beyond the Box

Our technical helpline gives plumbers real support when they need it most - quick advice, troubleshooting, even site visits.

Plumbers can fit with confidence, knowing expert help is always just a call away.

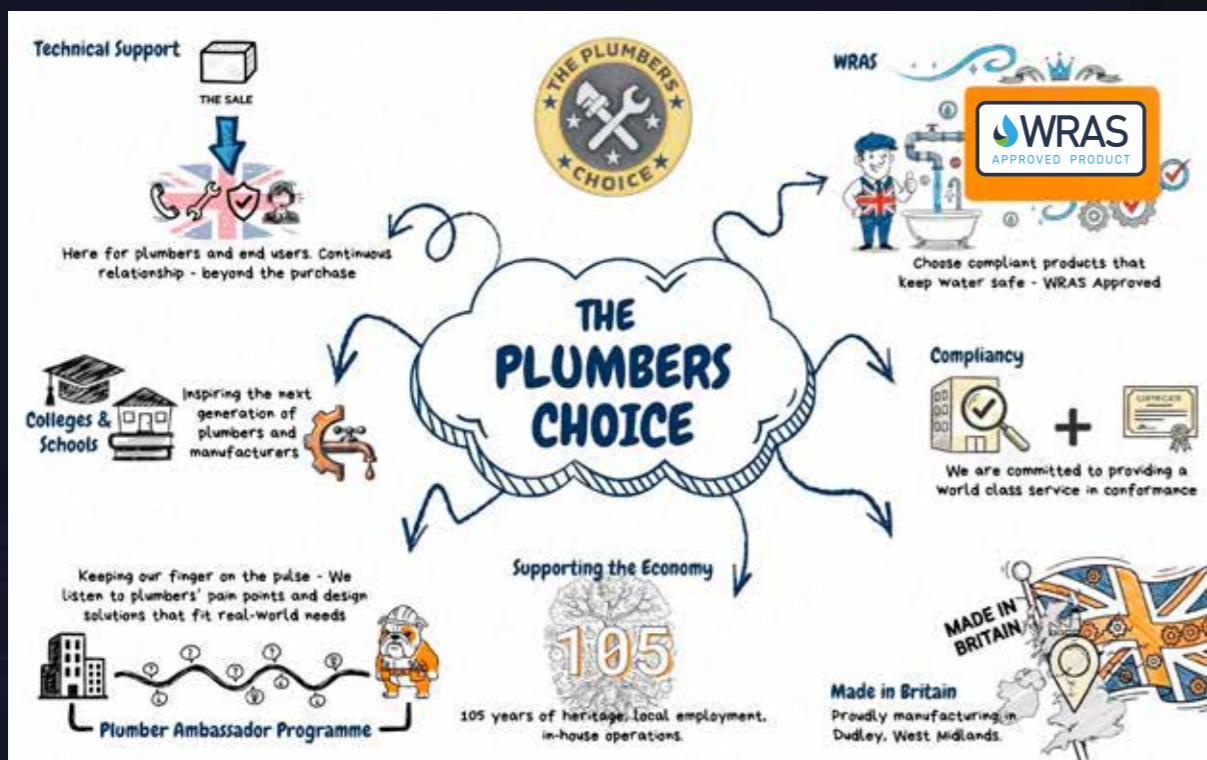

DESIGN

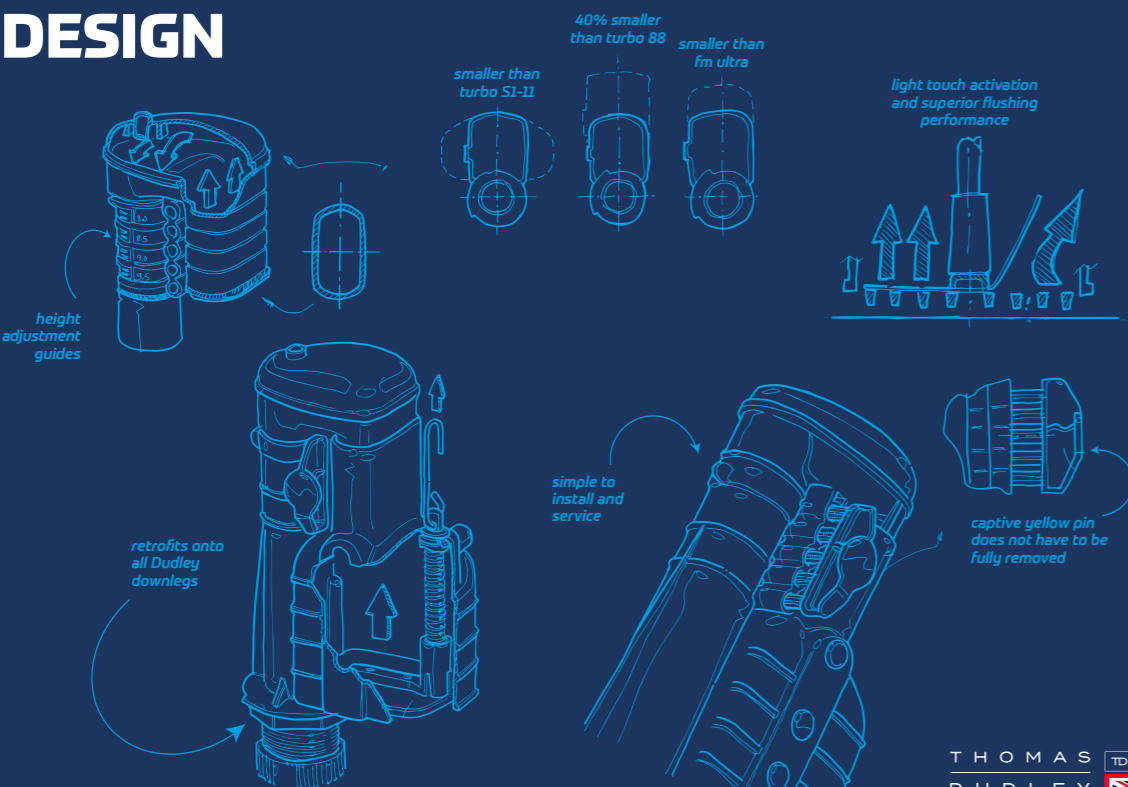

height adjustment guides

40% smaller than turbo 88

smaller than turbo 51-11

smaller than fm ultra

light touch activation and superior flushing performance

retrofits onto all Dudley downlegs

simple to install and service

captive yellow pin does not have to be fully removed

THOMAS DUDLEY 

Leading the way in Plumbing Excellence

Thomas Dudley manufactures top-quality plumbing products in our cutting-edge UK facilities, trusted by professional installers whose feedback drives our innovation.

With expertise in fluid dynamics and water control, our products are rigorously tested to meet the UK Water Supply (Water Fittings) Regulations 1999 and all relevant national standards.

Explore our wider product ranges, point of sale options and specialist brands in the brochures / page links below.

Specification Brochure



Epson Wastes Brochure



Point of Sale Options



How To



FAQs



Case Studies



Resan Product Brochure



Resan Application Guide



Bailey Product Brochure



Leaky Loos - Why Syphons are the answer?

In the world of plumbing, efficiency and reliability are paramount.

One of the most significant advancements in toilet technology is the introduction of the toilet syphon. This innovative solution addresses the persistent issue of leaks, offering a Leak-Free, water-saving alternative to traditional valves. Designed with both the environment and cost-effectiveness in mind, toilet syphons are revolutionising the way we think about water conservation and plumbing maintenance. Discover why toilet syphons are the superior choice for any specification project.

The Leak-Free Solution

Toilet syphons are the ultimate answer to the leaky loo crisis. Unlike traditional valves, syphons are designed to be Leak-Free, ensuring that water stays where it should be – in the cistern until it's needed. This innovative technology eliminates the common issue of leaks, which not only conserves water but also saves money and time on repairs.

Minimum Water Wastage

With a syphon, you can be confident that every drop of water is used efficiently. The syphon mechanism ensures minimum water wastage, making it a superior choice for those committed to water conservation. This is particularly important in today's world, where every effort to save water counts.

Easy Installation and Maintenance

Syphons are not only effective but also easy to install and maintain. Their straightforward design means that they can be fitted quickly and require minimal upkeep, reducing the hassle for both installers and users. This makes them a cost-effective solution for any plumbing system.

Cost-Effective and Reliable

Switching to a syphon from a valve can significantly reduce the risk of leaks, which are a major cause of water wastage and high utility bills. By fitting a toilet syphon, you can reduce leaks to practically zero, offering a cost-effective and reliable solution that can save around £150 per toilet per year.



The Science Behind Syphons

So, how does a syphon succeed where a valve fails? To quote our Product Director, "...through an elegant symphony of physics and engineering, aptly termed – Syphonic Technology...". A syphon has the unique ability to cause a liquid to flow upward, acting like a miniature water lift. This upward flow is crucial for preventing leaks, as it ensures that water only moves when it is supposed to, unlike valves that can fail and cause continuous leaks.

A Practical Solution for the Leaky Loo Problem

A valve lacks the water lift technology of a syphon and is prone to leaks, which is the enemy of water conservation. Simply

put, no upward flow means no leak-proof guarantee. Our syphon technology offers a practical solution to the infamous leaky loo problem that aligns with DEFRA's proposed changes to water regulations. For all those involved in the building and maintenance sectors, facilities management, and water industries, it's time to sit up and take notice. The future of Leak-Free, water-saving flushing technology is available now – the reliable, Leak-Free toilet syphon!

Quantum Technology

– The New Standard in Push-Button Syphonic Flushing

Introducing a New Generation of Leak-Free Push-Button Syphons

We are proud to introduce Quantum Technology, our new umbrella platform for any Dudley syphon activated by a push button. This marks a major evolution in flushing innovation, bringing together our latest developments in leak-free syphonic engineering, water efficiency, and modern user-friendly operation.

The Quantum range includes both our pioneering Quantum Push-Button Syphon and the newly launched Turbo Edge Quantum Syphon, combining advanced syphonic performance with the convenience of push-button activation. The result is a family of products that delivers unparalleled reliability, installation simplicity, and long-term water saving.

Quantum Technology - key Features:

Push-Button Syphonic Operation: Quantum Technology brings together our push-button operated, mechanically activated syphons. Each model uses a user-friendly push button (available in a range of styles), delivering a smooth, intuitive flush every time while maintaining the inherent reliability and leak-free benefits of a traditional syphon.

Leak-Free Syphonic Engineering: Designed and engineered in the UK, every Quantum product uses advanced syphonic technology to lift water without power assistance, eliminating the leaks commonly associated with flush valves. This not only improves durability but significantly reduces water wastage - helping users cut both environmental impact and water bills.

Expanded Range, Wider Compatibility: Alongside the original Quantum Syphon, the new Turbo Edge Quantum Push-Button Syphon extends the platform with enhanced versatility. Built on the proven Turbo Edge architecture, it offers height adjustment from 191-241 mm and compatibility with a wide range of cisterns, making it an ideal upgrade for both new and existing systems.

Easy Installation and Low Maintenance: All Quantum products have been designed with plumbers, installers, and maintenance teams in mind. Features such as fully captive fixing pins, modular construction, and simplified servicing ensure fast installation and reduced maintenance compared to valve-based systems. This allows professionals and end users to experience the benefits of Quantum Technology with minimal disruption.

Durable, High-Quality Construction: Manufactured from robust, high-performance materials, the Quantum range is built to withstand the demands of daily use in both residential and commercial environments. Longevity and reliability sit at the core of the Quantum platform, ensuring excellent value throughout its lifecycle.

A Message from Mark Morris, Head of Marketing
"Quantum Technology marks the beginning of a new era for our syphonic product range. By bringing together the world's first push-button operated syphon with the versatility of the new Turbo Edge Quantum model, we are delivering the biggest breakthrough in leak-free water-saving toilet technology for decades.

Enough water leaks from UK toilets every day to fill millions of baths, and the Quantum platform is our direct response to that problem. By combining the natural leak-free performance of a syphon with the convenience of push-button activation, we are redefining what customers can expect in both performance and sustainability. Our commitment to engineering innovation and environmental responsibility shines through every Quantum product."



New Products



eco-cistem™ Concealed Cistern

TOILET CISTERNS // WASHROOM FILL & FLUSH

- The only cistern to re-use condensate from air-conditioners to provide free water to flush toilets
- Reusing waste water with back up mains water supply; ensures that a full toilet flush is available even when usage frequency is high
- Stores 18 litres of water
- No electricity required
- If the toilet is not used for a while, surplus condensate is simply drained away
- Reduces carbon footprint by conserving water that would ordinarily go to waste, lowering overall water demand
- Considering a 1.75kw aircon unit, one of the smallest on the market, can produce over 1 litre of condensate per hour, an eco-cistem™ installation will always make substantial savings on freshwater usage



eco-cistem™ in partnership with Thomas Dudley, uses the condensation produced by air conditioning units to flush toilets. Until now, this free, sustainable source of water has gone to waste.

- The world's most environmentally friendly toilet cistern
- Combines sustainable design with smart functionality

Product	Code
eco-cistem™	377372



Visit our website



Approved fittings

New Products

eco-cistem™ Case Study One City Park, Bradford

41 eco-cistem™ units installed
Estimated annual water savings: 600,000 litres

One City Park is a landmark commercial office development in the heart of Bradford - marking the city's first new office building in over 25 years. Completed in 2024 ahead of the Bradford City of Culture 2025 celebrations, the five-storey, 56,000 sq ft Grade A facility sets a new benchmark for sustainable design and digital connectivity.

The building has achieved:

- Gold SmartScore certification*
- Gold WiredScore certification**
- BREEAM Excellent rating***

G&H were appointed by main contractor Caddick Construction to deliver full mechanical, electrical, and public health (MEP) design and build services. Their work included the integration of rooftop photovoltaic panels, air source heat pumps, and ten EV charge points - each contributing to the building's high-performance credentials.



To further reduce environmental impact, G&H specified and installed 41 eco-cistem™ units across the building - approximately 12 per floor. These innovative cisterns repurpose grey condensate water generated by the building's air conditioning system, using it to flush toilets instead of drawing on mains water.

Each eco-cistem™ unit features:

- A patented 18-litre twin-chamber cistern
- 12-litre upper chamber for grey water storage
- 6-litre lower chamber for flushing
- Automatic prioritisation of grey water, with mains backup only when needed

This smart reuse of condensate water ensures consistent flushing performance while dramatically reducing freshwater consumption.

"The eco-cistem™ units are an ideal way to harness the grey condensate water produced by the air conditioning system," says David Davis, Pre-Construction Director at G&H. "Using our bespoke calculator, we modelled annual condensate output, flush frequency, and water costs. The result was a projected return on investment in under three years - while supporting the building's sustainability goals."

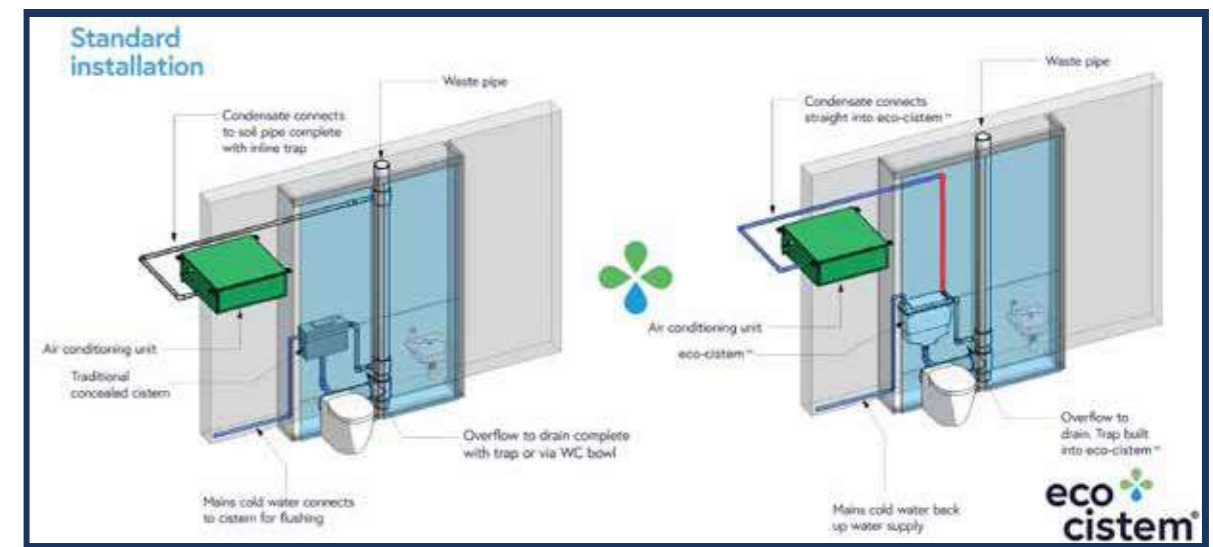

Shown here as a single-unit install, eco-cistem™ is fully scalable—ideal for hotels, flats, and offices. Multiple units fit standard service voids, with a full design guide available at eco-cistem.com.

* Recognises smart buildings that deliver exceptional user experience, sustainability, and future-readiness ** Assesses digital infrastructure, resilience, and connectivity. *** Measures environmental performance across a building's lifecycle

New Products - Quantum Technology

Quantum - The World's first Push Button Syphon

SYPHONS // WASHROOM FILL & FLUSH

- Innovative pushbutton operation with a mechanically activated syphon, comes equipped with a user-friendly pushbutton mechanism
- Leak-Free syphonic technology designed and engineered in the UK from high-quality materials
- The Leak-Free design enhances the durability of the valve; contributing to water conservation efforts as we are committed to sustainability
- Optimises water usage by eliminating leaks without compromising performance
- Easy installation and maintenance
- Reliable and cost-effective choice for residential and commercial applications

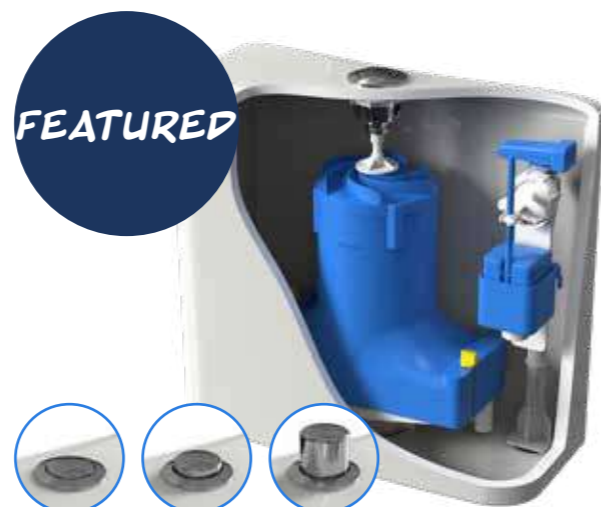

FEATURED
Push button operation with a choice of caps; flush, low profile and palm push

- Syphons use a unique water lift mechanism, moving water upward before gravity takes over, ensuring a leak-free flush
- No dynamic seal beneath the waterline; eliminating the primary cause of leaks and promoting water conservation

Product	Code
Quantum	375252



Turbo Edge Quantum Push Button Syphon

SYPHONS // WASHROOM FILL & FLUSH

- Leak-Free Valve Replacement
- User-friendly light-touch operation
- Water saving Duoflush as standard. Press and hold for full flush, press and release for reduced flush
- 6 / 7 / 9 litre volume adjustment guaranteeing optimum flush performance
- Perfect for use in close-coupled toilets to replace existing flush valves
- Height adjustable from 7.½" (191mm) to 9.½" (241mm)
- Comes with both low profile chrome flush buttons and palm push button to suit your preference
- Supplied with adaptor for 51mm (2") outlet
- Fully captive yellow fixing pin does not need to be removed to install syphon, easing installation
- Suitable for Cistern Internal Height: Min: 350mm - Max: 425mm
- Suitable for Water Level: Min: 170mm - Max: 220mm



NEW
The Best Performing Syphon That Fits All Cisterns
Push button operation with a choice of caps; slight and palm push

Product	Code
Turbo Edge Quantum	377390



New Products

VICTORIA™ OUTLET VALVES

SIMPLIFY YOUR SYSTEM 3 VALVES IN 1

- Extended Dudley Outlet range
- Cable | Mechanical | Long Cable | Lever Option
- Now supplied with our NEW Valve Mate - retrofits: Dudley Victoria, FM Pro550 and WQ Kayla
 - Time saving; no need to dismantle
 - Retrofits all Dudley Victoria options, FM Pro 550 and WQ Kayla
 - Quick and easy to retrofit in under 30 seconds
 - Inside and outside of cistern assembly
- Long life silicone seal
- Serviced in under 5 mins
- Water Saving
- Button mounted on front or top of cistern

Product	Code
Victoria Cable Operated Dualflush Valve [300mm]	325648
Victoria Cable Operated Dualflush Valve [470mm]	375036
Victoria Mechanical Dualflush Outlet Valve	373328
Victoria Lever Operated Dualflush Outlet Valve	373332



VALVE MATE™
NOW INCLUDED IN THE VICTORIA OUTLET VALVE BOX

Retrofits:
Dudley Victoria
FM Pro550
WQ Kayla



Niagara® Pneumatic Flush Valve

We are thrilled to announce some exciting updates to our Niagara Pneumatic Flush Valve; reflecting our commitment to continuous development

- Continuous Improvement: Ongoing efforts to enhance product performance and reliability
- Compatibility: This is the same trusted product and remains fully compatible with older Niagara valve cages
- Enhanced Visuals: Now in blue, perfectly aligned with our Dudley brand
- Updated design allows for maximum pump volume usage on Electroflo WC models

Item	Code
Niagara Pneumatic Dualflush Valve	327628

Washroom Control System

Introducing our NEW Dudley Resan Washroom Control System with 4 channels

- A complete washroom water management system that allows control of any combination of hot and cold taps, shower outlet and WC
- Activation of all controls using either infra-red sensors or piezo buttons
- Visual display for easy programming with tactile program buttons
- Programmable run time of hot & cold taps and showers

Item	Code
Washroom Control System only	374572

Resan® Left | Right Hand Corner Pans & Inset Basins

Presenting our latest innovations; the Resan Left/Right Hand Corner Pans and the Inset Basin. Designed with precision and crafted in our state-of-the-art UK facilities

- Pan**
- Damage resistant and Anti-ligature
 - Available in both left & right hand orientation
 - Designed for seatless use
- Basin**
- Damage resistant and Anti-ligature
 - Fits where space is at a premium
 - Piezo or Pneumatic controls – Sold Separately

See pages 67 & 68 for more details

Washroom fill & flush

Our fill and flush toilet products have been developed by expert plumbers who truly understand the needs and preferences of both installers and users. Each and every toilet part we manufacture here in the UK has been created to the highest of standards and we're proud of the unrivalled reputation our Dudley toilet parts have among professional installers. Our fill and flush products are not only superior quality, they've also been designed with a quick and simple fit in mind so you can install them swiftly and move on to the next job.

For live product lead times please visit our website.



In this section

01	»Buttons & Push Plates	22	07	»Touch-Free Soap Dispensers	58
02	»Frames	30		Taps	59
03	»Inlet Valves	35		Urinal Controls	60
04	»Outlet Valves	40		WC Controls	62
05	»Syphons	42		Accessories	63
06	»Toilet Cisterns	48	08	»Resan WC Pans & Toilets	64
	Concealed Cisterns	48		Sinks & Basins	65
	Exposed Cisterns	52		Urinal Units	68
	Auto Cisterns	53		Mirror Frames & Shelving	69
	Cistern Options	54		Intelligent Controls	70
				Options	72

Visit our website

Visit our website and search our extensive range of plumbing parts, find key product information such as technical specifications, installation and troubleshooting guides and create your order all in one place using our Quote Builder function.



01 Buttons & Push Plates

FEATURED

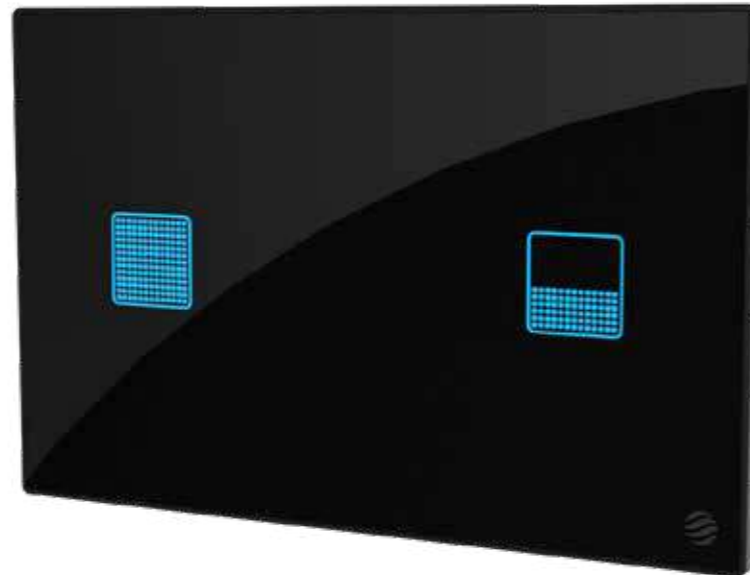

Wave S3 – Push Plate

BUTTONS & PUSH PLATES // WASHROOM FILL & FLUSH

Wave S3 Touch-Free Electronic Push Plate

- 242mm [W] x 156mm [H] x 12mm [D]
- Electronic Dualflush Feature
- Touch-Free

Type	Code
Square Corners	330261
Radius Corners	330262

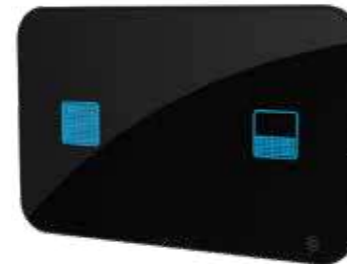

The Wave™ S3 Intelligent Flush Actuator is a high-end flushing solution for commercial and domestic installations that demand a premium finish.

In conjunction with a Dudley Niagara Pneumatic this intuitive, touch free flush actuator provides a full and a water saving reduced flush.

The Wave S3 features illuminated flush status icons to provide visual feedback: Blue: User detected and ready to flush. Green: Flush activated. Red: Cistern filling.

- Electronic dualflush feature
- Touch-free



Visit our website for Buttons & Push Plates



Buttons & Push Plates 01

WAVE S2 – PUSH PLATE

BUTTONS & PUSH PLATES // WASHROOM FILL & FLUSH

Wave S2 Touch-Free Electronic Push Plate

- 229mm [W] x 149mm [H] x 10mm [D]
- Electronic Dualflush Feature
- Touch-Free

Type	Code
Wave S2 – Push Plate	326395



WAVE S1 – PUSH PLATE

BUTTONS & PUSH PLATES // WASHROOM FILL & FLUSH

Wave S1 Touch-Free Electronic Push Plate

- 229mm [W] x 149mm [H] x 10mm [D]
- Electronic Dualflush Feature
- Touch-Free

Item	Code
Wave S1 – Push Plate	326394



01 Buttons & Push Plates

FEATURED



Geo - Dualflush Pushbutton 73.5mm POLISHED CHROME

- 73.5mm Diameter Pushbutton
- Dualflush feature
- Simple yet contemporary in design
- Smooth pneumatic operation
- Can be positioned up to 250mm from the cistern
- Chrome as standard - other finishes available
- Standard supplied button is suitable for wall thicknesses up to 50mm. For wall thicknesses greater than 50mm use the alternate code provided

Finish / Packaging	Wall Thickness	Code
Chrome / Boxed	<50mm	372937
Chrome / Bagged	<50mm	372873
Brushed Nickel / Bagged	<50mm	372871
Matt Black / Bagged	<50mm	372938
Soft Touch Grey / Bagged	<50mm	373557
Satin Brass / Bagged	<50mm	375056
Bronze / Boxed	<50mm	379354
Gunmetal / Boxed	<50mm	379355
Chrome / Bagged	>50mm	375698
Brushed Nickel / Bagged	>50mm	375701
Matt Black / Bagged	>50mm	375699
Soft Touch Grey / Bagged	>50mm	375700
Satin Brass / Bagged	>50mm	376165
Bronze / Boxed	>50mm	379359
Gunmetal / Boxed	>50mm	379358



Dio - Dualflush Pushbutton 51mm POLISHED CHROME DUALFLUSH PUSHBUTTON

- 51mm Diameter Pushbutton
- Dualflush feature
- Chrome as standard - other finishes available

Packaging/Finish	Code
Chrome / Boxed	327733
Chrome / Bagged	322408
Brushed Nickel / Bagged	374422
Black / Bagged	371008
Satin Brass / Bagged	375054



Miniflo Polished Chrome - Dualflush Pushbutton

- 51mm POLISHED CHROME
DUALFLUSH PUSHBUTTON
- 51mm Diameter Pushbutton
 - Dualflush feature

Packaging/Finish	Code
Chrome / Bagged	322905

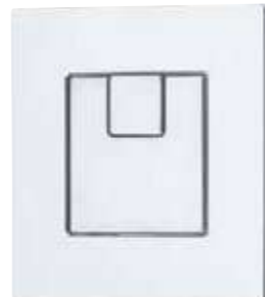

Piazza - Square Dualflush Pushbutton

- 73.5mm SQUARE DUALFLUSH PUSHBUTTON
- 73.5mm Diameter Pushbutton
 - Dualflush feature
 - Chrome as standard - other finishes available

Packaging/Finish	Code
Chrome / Boxed	327734
Chrome / Bagged	325276
Brushed Nickel / Bagged	374974
Black / Bagged	375286
Satin Brass / Bagged	375055

Buttons & Push Plates 01



Royal Twin Palm - Pushbuttons

51mm PALM PUSH DUALFLUSH PUSHBUTTON

- 51mm Diameter Pushbutton
- Dualflush feature
- Palm Push

Item	Code
Royal Twin Palm - Pushbutton	327655



Remora Twin - Pushbutton

55mm PALM PUSH DUALFLUSH PUSHBUTTON

- 55mm Diameter Pushbutton
- Dualflush feature
- Polished Stainless Steel or Satin Stainless Steel finishes available

Item	Code
Remora Twin - Polished Stainless Steel Pushbutton	330017
Remora Twin - Satin Stainless Steel Pushbutton	330018

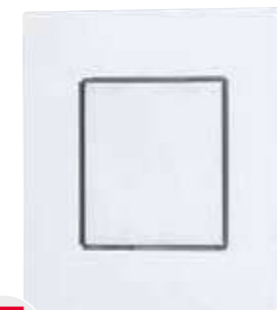

Piazza - Square Single Flush Pushbutton

73.5mm SINGLE FLUSH PUSHBUTTON

- Single Flush
- Chrome Finish

Item	Code
Piazza - Square Single Flush Pushbutton	325277



CP Round - Single Flush Pushbutton

73.5mm CHROME SINGLE FLUSH PUSHBUTTON

- 73.5mm Diameter Pushbutton
- Single Flush
- Chrome Plated
- Boxed and Unboxed available on certain buttons

Finish/Packaging	Code
Chrome Plated Boxed	327736
Chrome Plated Unboxed	313085



Remora - Pushbutton

50mm REMORA SINGLE FLUSH PUSHBUTTON

- 50mm Diameter
- Single Flush
- Stainless Steel & Satin finishes available

Item	Code
Remora - Satin Stainless Steel Pushbutton	330019
Remora - Polished Stainless Steel Pushbutton	328155

01 Buttons & Push Plates



Royal Pushbutton

51mm SINGLE FLUSH PUSHBUTTON

- 51mm Diameter Pushbutton
- Single Flush
- Chrome Finish

Packaging	Code
Royal (Boxed)	327735
Royal (Unboxed)	313621



Palm Push Royal - Pushbutton

51mm SINGLE FLUSH PUSHBUTTON

- 51mm Diameter Pushbutton
- Single Flush
- Chrome Finish

Packaging	Code
Palm Push Royal - Pushbutton	324379



Dome - Pushbutton

91mm SINGLE FLUSH PUSHBUTTON

- 91mm Diameter Pushbutton
- Single Flush
- Chrome Finish
- * Can Only be used with the Dudley Pinto flushing valve

Item	Code
*Dome - Pushbutton	316562



Petite - Pushbutton

46mm SINGLE FLUSH PUSHBUTTON

- 46mm Diameter Pushbutton
- Single Flush
- Chrome Finish
- * Can Only be used with the Dudley Pinto flushing valve

Item	Code
*Petite - Pushbutton	320185



Cone - Pushbutton

50mm SINGLE FLUSH PUSHBUTTON

- 50mm Diameter Pushbutton
- Single Flush
- Chrome Finish
- * Can Only be used with the Dudley Pinto flushing valve

Item	Code
*Cone - Pushbutton	316269

Buttons & Push Plates 01



Flat Metal - Pushbutton

FLAT METAL VANDAL RESISTANT SINGLE FLUSH PUSHBUTTON

- 63.5mm Diameter
- High impact vandal-resistant stainless steel construction
- Flat metal button cannot be unscrewed from the front, providing an anti-ligature solution
- **Only** works with Pushflo concealed cistern and can **only** be used with Pinto Flushing Valve
- Extended spacer to suit Dudley Niagara Flush Valve available [330153]

Item	Code
Flat Metal - Pushbutton	319473



Metal Royal - Pushbutton

METAL ROYAL SINGLE FLUSH PUSHBUTTON

- 51mm Diameter
- Stainless steel construction
- Smooth pneumatic operation
- Single Flush

Item	Code
Metal Royal - Pushbutton	321685



Metal Remora - Push Plate

METAL REMORA VANDAL RESISTANT PUSH PLATE

- 229mm [W] x 149mm [H] x 10mm [D]
- High impact vandal-resistant stainless steel construction
- Flat metal button cannot be unscrewed from the front, providing an anti-ligature solution

Item	Code
Stainless Steel Remora Push Plate	327227



Metal Pearl - Push Plate

PEARL STAINLESS STEEL VANDAL RESISTANT PUSH PLATE

- 125mm [W] x 82mm [H] x 8mm [D]
- High impact vandal-resistant stainless steel construction
- Flat metal button cannot be unscrewed from the front, providing an anti-ligature solution

Item	Code
Metal Pearl Push Plate	326488

01 Buttons & Push Plates

FEATURED



Drift - Dualflush Push Plate

POLISHED CHROME

- 242mm [W] x 156mm [H] x 12mm [D]
- Dualflush Feature
- Smooth pneumatic operation
- Anti-finger trap design
- Chrome Finish as standard
- Alternative finishes available

Finish / Packaging	Code
Drift™ Dualflush Push Plate - Chrome / Boxed	372565
Drift™ Dualflush Push Plate - Brushed Nickel / Boxed	372925
Drift™ Dualflush Push Plate - Matt Black / Boxed	372918
Drift™ Dualflush Push Plate - Soft Touch Grey / Boxed	373324
Drift™ Dualflush Push Plate - Satin Brass / Boxed	375049
Drift™ Dualflush Push Plate - Bronze / Boxed	376892
Drift™ Dualflush Push Plate - Gunmetal / Boxed	376891

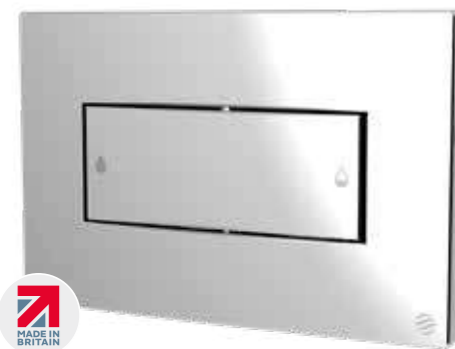

Coral - Push Plate

POLISHED CHROME

- 232mm [W] x 152mm [H] x 14mm [D]
- Dualflush Feature
- Smooth pneumatic operation
- Chrome Finish as standard
- Alternative finishes available

Finish	Code
Coral™ Dualflush Push Plate - Chrome / Boxed	326392
Coral™ Dualflush Push Plate - Brushed Nickel / Boxed	373568
Coral™ Dualflush Push Plate - Matt Black / Boxed	375774
Coral™ Dualflush Push Plate - Soft Touch Grey / Boxed	373556
Coral™ Dualflush Push Plate - Satin Brass / Boxed	375057

Buttons & Push Plates 01



Reef - Push Plate

POLISHED CHROME

- 232mm [W] x 152mm [H] x 14mm [D]
- Dualflush Feature
- Smooth pneumatic operation
- Chrome Finish as standard
- Alternative finishes available

Finish	Code
Reef - Chrome	326393
Reef - Brushed Nickel	373567
Reef - Matt Black	375775
Reef - Soft Touch Grey	373555
Reef - Satin Brass	375050



Oyster - Push Plate

OYSTER DUALFLUSH PUSH PLATE

- 232mm [W] x 152mm [H] x 16mm [D]
- Dualflush Feature
- Chrome Finish
- Alternative finishes available

Item	Code
Chrome Oyster Push Plate	322903

Pebble - Push Plate

PEBBLE DUALFLUSH PUSH PLATE

- 232mm [W] x 152mm [H] x 16mm [D]
- Dualflush Feature
- Chrome Finish

Item	Code
Chrome Pebble Push Plate	322904

Pearl / Pearl Palm - Push Plate

PEARL / PEARL PALM DUALFLUSH PUSH PLATE

- 125mm [W] x 82mm [H] x 8mm [D]
- Dualflush Feature
- Chrome Finish

Item	Code
Chrome Pearl Push Plate	324697
Chrome Pearl Palm Push Plate	324762

02 Frames

FEATURED

Dudley Illusion A

FRAMES // WASHROOM FILL & FLUSH

Height adjustable wall-hung WC pan support frame designed for use against flat walls and in corners

- Unique design enables frame to be set between 820mm and 1078mm for unrivalled installation flexibility
- Integral factory fitted Dudley Vantage cistern
- Floor brackets rotate through 360°
- Available for use with various buttons operated by the Dudley Niagara Pneumatic Flush Valve
- Vantage cisterns are available with a Type AB weir overflow (Fluid Category 5 Compliant)
- Wall and floor fixing brackets can be fixed through 180 degrees and 360 degrees respectively to simplify installation
- Strong steel tubular section
- Height adjustable

Type	Code
Illusion A Frame, Vantage DF Cistern, No Button/Plate (With Jacket)	325685
Illusion A Frame, Vantage DF Cistern, No Button/Plate (No Jacket)	325686
Dudley Illusion A with Phantom™ Cistern, Bottom Entry, Less Able Lever	334923

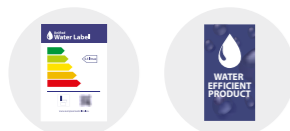

Visit our website for Frames



The Dudley Illusion range of support frames are ideal for use with most wall-hung sanitaryware. They also provide a proven solution behind panelling and tiles and in fitted bathroom furniture. Illusion A and V frames incorporate an integral Vantage cistern that can be quickly and easily converted to deliver factory set to 6/4L convertible to 5/3-4/2-6L dualflush to support BREEAM and other initiatives. Illusion Universal and Compact Universal frames can be installed in conjunction with any Dudley concealed cistern to provide a bespoke water saving solution. Wall hung WC pan support frame designed for use against flat walls and in corners. Ideal for most domestic and commercial applications.

- Unique design
- Floor brackets rotate through 360°

Frames 02

DUDLEY ILLUSION V

FRAMES // WASHROOM FILL & FLUSH

Wall-hung WC pan support frame designed for use against flat walls and in corners

- Integral factory fitted Dudley Vantage cistern
- Fixed height frame, legs adjust to offer WC pan height fixing flexibility
- Available for use with various buttons operated by the Dudley Niagara Pneumatic Flush Valve
- Floor brackets rotate through 360°
- Wall and floor fixing brackets can be fixed through 180° and 360° respectively to simplify installation
- Strong steel tubular section
- Floor and WC pan fixing bolts included

Type	Code
Dudley Illusion V, Vantage DF Cistern, No Button/Plate (With Jacket)	323063
Dudley Illusion V, Vantage DF Cistern, No Button/Plate (No Jacket)	323139



DUDLEY ILLUSION UNIVERSAL

FRAMES // WASHROOM FILL & FLUSH

Height adjustable wall-hung WC pan support frame designed for use against flat walls and in corners

- Come with flushbend and WC pan connector clamps
- Legs adjust to offer WC pan height fixing flexibility
- Wall and floor fixing brackets can be fixed through 180 degrees and 360 degrees respectively to simplify installation
- Strong steel square hollow construction
- Load tested to 4kN to ensure compliance with BS EN 997 when fitted with a wall-hung pan
- Can be installed in conjunction with all Dudley concealed cisterns to provide a tailor made solution for every project

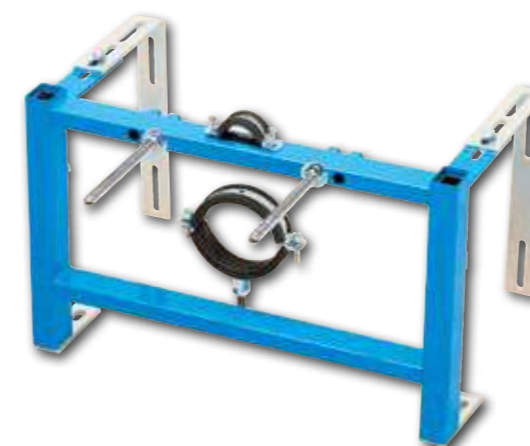

Item	Code
Dudley Illusion Universal	314802

02 Frames

DUDLEY ILLUSION COMPACT UNIVERSAL

FRAMES // WASHROOM FILL & FLUSH

Compact wall-hung WC pan support frame perfect for bathroom furniture and other confined spaces

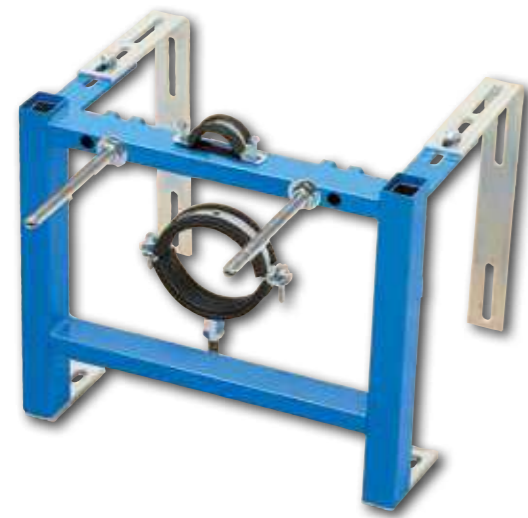

- With a width of 345mm the compact universal is perfect for bathroom furniture and other confined spaces
- Comes with flushbend and WC pan connector clamps
- Legs adjust to offer WC pan height fixing flexibility
- Load tested to 4kN to ensure compliance with BS EN 997 when fitted with a wall-hung pan
- Wall and floor fixing brackets can be fixed through 180 degrees and 360 degrees respectively to provide further flexibility
- Strong steel square hollow construction

Item	Code
Dudley Illusion Compact Universal	323082

DUDLEY ILLUSION BIDET

FRAMES // WASHROOM FILL & FLUSH

Wall-hung bidet support frame designed for use against flat walls and in corners



- Blue painted finish and zinc plated wall and floor brackets
- Legs adjust to up to 150mm to offer WC pan height fixing flexibility
- Wall and floor fixing brackets can be fixed through 180 degrees and 360 degrees respectively to simplify installation
- Strong steel tubular section
- Floor and bidet fixing bolts included

Item	Code
Dudley Illusion Bidet	314887

Frames 02

DUDLEY ILLUSION BASIN

FRAMES // WASHROOM FILL & FLUSH

Wall-hung basin support frame designed for use against flat walls and in corners



- Blue painted finish and zinc plated wall and floor brackets
- Fixed height frame, legs adjust to offer basin height fixing flexibility
- Wall and floor fixing brackets can be fixed through 180 degrees and 360 degrees respectively to simplify installation
- Strong steel tubular section
- Floor and basin fixing bolts included

Type	Code
Dudley Illusion Basin	319207

DUDLEY ILLUSION SENTINEL

FRAMES // WASHROOM FILL & FLUSH

Wall-hung WC pan support brackets. Ideal for most domestic and commercial applications.



- Strong cast iron construction
- Vertical slot offers WC pan height fixing flexibility
- Grey painted finish
- Load tested to 4kN to ensure compliance with BS EN 997 when fitted with a wall-hung pan
- Floor and WC Pan fixing bolts available as optional extras



Item	Code
Dudley Sentinel Bracket	317614

Frames – Options

Frame System and Cistern with Polystyrene Insulation Jacket and With:

Code	Product Name	Description
323063	Dudley Illusion 'V'	No Button / Plate

Dualflush

327280	Dudley Illusion 'V'	Dualflush CP Pearl Palm Push Plate
327210	Dudley Illusion 'V'	Dualflush CP Reef Plate

Single Flush

325636	Dudley Illusion 'V'	Palm Push CP Button (51mm)
--------	---------------------	----------------------------

6/4 Litre Dualflush (Converts to 5/3 or 4/2.6 Litre) (Button Packed with Cistern):

Frame System and Cistern with Polystyrene Insulation Jacket and With:

322805	Dudley Illusion 'V'	Dio CP Button (51mm)
323345	Dudley Illusion 'V'	Oyster Pushplate
324262	Dudley Illusion 'V'	Electroflo Touch Free Flushing and 40mm CP Sensor Surround - Mains

Frame system and Cistern without Polystyrene Insulation Jacket and With:

322577	Dudley Illusion 'V'	Dio CP Button (51mm)
--------	---------------------	----------------------

Single Flush (Button Packed with Cistern)

Frame System and Cistern with Polystyrene Insulation Jacket and With:

Code	Product Name	Description
325685	Dudley Illusion 'A'	No Button / Plate
325455	Dudley Illusion 'A'	Square Piazza CP Button (73.5mm)

Frame System and Cistern without Polystyrene Insulation Jacket and With:

325458	Dudley Illusion 'A'	Palm Push CP Button (51mm)
--------	---------------------	----------------------------

6/4 Litre Dualflush (Converts to 5/3 or 4/2.6 Litre) (Button Packed with Cistern):

Frame System and Cistern with Polystyrene Insulation Jacket and With:

325469	Dudley Illusion 'A'	Square Piazza CP Button (73.5mm)
325467	Dudley Illusion 'A'	Round/Round CP Button (73.5mm)
326644	Dudley Illusion 'A'	Reef CP Plate
325468	Dudley Illusion 'A'	Dio CP Button (51mm)
325470	Dudley Illusion 'A'	Oyster Push Plate
325476	Dudley Illusion 'A'	Electroflo Touch Free Flushing and 40mm CP Sensor Surround (Mains Power)
325475	Dudley Illusion 'A'	Electroflo Touch Free Flushing and 100mm CP Commercial Sensor Surround (Mains Power)

Frame System and Cistern without Polystyrene Insulation Jacket and With:

325464	Dudley Illusion 'A'	Square Piazza CP Button (73.5mm)
325463	Dudley Illusion 'A'	Dio CP Button (51mm)
325461	Dudley Illusion 'A'	Oyster Push Plate

Code	Product Name	Description
325405	Extra	Chrome 40mm Surround for Dudley 'Electroflo' Sensor
330092	Extra	Fixing Pack for Dudley Illusion 'V' and 'A' Frames
326696	Extra	Fixing Pack for Dudley Illusion Compact Universal Frame

For standard frame options, please see pages 30-33

Inlet Valves 03



Hydroflo Airgap Compact Float Valve

INLET VALVES // WASHROOM FILL & FLUSH

Hydroflo compact delay fill bottom inlet valve with brass tail

- Supplied with 'Air Gap' as standard since 2004
- Water regulations compliant replacement inlet valve for most modern ceramic & plastic cisterns
- Fixed height bottom inlet valve, ensure fitment is appropriate for the size of cistern. (241mm 9.5" recommended for most applications)
- Compact float will not catch on tight cistern installations where the inlet valve is close to the syphon or outlet valve, ensuring perfect operation
- Wide waterline adjustment range of 140mm to 220mm
- Professional ½" BSP connection with brass tail
- Water saving delay fill action
- Time saving, flow regulation works for all water pressures; no need for removal
- Patented integrated quiet fill action
- New simple and efficient 2-piece filter design
- Unique float arm - impossible for the float to become detached

Size	Code
Hydroflo Airgap Compact Float Valve - 203mm (8")	370908
Hydroflo Airgap Compact Float Valve - 216mm (8.½")	370909
Hydroflo Airgap Compact Float Valve - 229mm (9")	370910
Hydroflo Airgap Compact Float Valve - 241mm (9.½")	334604
Hydroflo Airgap Compact Float Valve - 254mm (10")	370912
Hydroflo Airgap Compact Float Valve - 267mm (10½")	370913
Hydroflo Airgap Compact Float Valve - 280mm (11")	370914
Hydroflo Airgap Compact Float Valve - 292mm (11.½")	370915
Hydroflo Airgap Compact Float Valve - 305mm (12")	370916



- Air Gap as standard
- Unique float arm

Dudley Hydroflo Float Valves are Equilibrium Quiet Filling Part 4 Valves, manufactured to BS1212 standards. These are available in side or adjustable bottom inlet from 8" to 11.½", with either a plastic or brass tail option to help prevent cross-threading. The unique float arm makes it impossible for the float to become detached. Simple and easy to install, this valve is a great replacement for any cistern.

Visit our website for Inlet Valves



03 Inlet Valves



HYDROFLO AIRGAP SIDE INLET DELAY FILL

INLET VALVES // WASHROOM FILL & FLUSH

Hydroflo side inlet compact float valve with brass tail or plastic tail

- Supplied with 'Air Gap' as standard since 2004
- Supplied fitted with an integral flow regulator
- New simple and efficient 2-piece filter design
- ½" Brass Tail or Plastic Tail
- The unique side inlet float arm makes it impossible for the float to become detached.

Type	Code
Side Inlet Delay Fill Brass Tail	324298
Side Inlet Delay Fill Plastic Tail	334686



Inlet Valves 03



Hydroflo Telescopic Compact Float Valve

INLET VALVES // WASHROOM FILL & FLUSH

Hydroflo Telescopic compact delay fill bottom inlet valve with brass tail

- Adjustable Height 8" – 11.½"
- Compact body and float assembly
- Supplied fitted with an integral flow restrictor
- New simple and efficient 2-piece filter design
- Unique float arm makes it impossible for the float to become detached
- Professional ½" BSP connection with brass tail
- Telescopic valves can have a joint beneath the waterline when installed. To ensure full compliance to water regulations when fitting, please ensure the joint is above the critical waterline



Type	Code
Hydroflo Telescopic	324301

- Unique float arm
- Adjustable Height 8" – 11.½"



Hydroflo Telescopic Bottom Inlet Standard Fill Brass Tail

HYDROFLO TELESCOPIC BOTTOM INLET VALVE WITH BRASS TAIL

- New simple and efficient 2-piece filter design
- Supplied fitted with an integral flow restrictor
- Adjustable Height 8" – 11.½"
- ½" Brass Tail

Item	Code
Hydroflo Telescopic Bottom Inlet Standard Fill Brass Tail	324302



Hydroflo Side Inlet Standard Fill Brass Tail

HYDROFLO SIDE INLET VALVE WITH BRASS TAIL

- Supplied with 'Air Gap' as standard since 2004
- Supplied fitted with an integral flow regulator
- New simple and efficient 2-piece filter design
- ½" Brass Tail
- The unique side inlet float arm makes it impossible for the float to become detached

Item	Code
Hydroflo Side Inlet Standard Fill Brass Tail	324299

Designed for use as a replacement in most plastic and ceramic exposed and concealed cisterns. Compact delay fill models save water and support BREEAM by only allowing a cistern to start refilling once flushing is complete. The unique inlet float arm makes it impossible for the float to become detached. This high quality inlet valve has a built in backflow prevention device making it one of the safest valves available. Hydroflo Telescopic delay fill bottom inlet valve with brass tail.

Telescopic valves can have a joint beneath the waterline when installed. To ensure full compliance to water regulations when fitting, please ensure the joint is above the critical waterline.



03 Inlet Valves



DUDLEY BETA+ SIDE INLET VALVE

INLET VALVES // WASHROOM FILL & FLUSH

Part 3 Side Inlet Valve with plastic or brass tail.

- Fits virtually all float operated cisterns
- 5/16" BSW thread size
- Unique float arm can be fixed in 3 positions
- Float arm extends from 185mm - 285mm
- Quickly adjust to not obstruct other cistern components
- Plastic / Brass Tail



Tail	Code
Plastic	332316
Brass	327640



DUDLEY BETA+ BOTTOM INLET 9" PART 3 FLOAT VALVE

INLET VALVES // WASHROOM FILL & FLUSH

Dudley Beta+ Bottom Inlet 9" (229mm) Part 3 Float Valve, Adjustable Arm.

- Fits virtually all float operated cisterns
- 5/16" BSW thread size
- Easy Installation
- Designed and manufactured in the UK to BS1212 Standard
- Unique float arm can be fixed in 3 positions
- Float arm extends from 185mm - 285mm



Item	Code
Dudley Beta Fixed Bottom Inlet Valve	332318



DUDLEY BETA+ BRASS TELESCOPIC BOTTOM INLET VALVE

INLET VALVES // WASHROOM FILL & FLUSH

Dudley Beta+ Brass Telescopic Bottom Inlet Brass Tail Part 3 Ball Valve with Thomas Dudley Back Plate, Adjustable and Swivel Arm

- Fits virtually all float operated cisterns
- 5/16" BSW thread size
- Patented multi-directional adjustment
- Easy Installation
- Unique float arm can be fixed in 3 positions
- Designed and manufactured in the UK to BS1212 Standard
- Swivel adjustment allows the float to be fixed through 180 degrees
- Float arm extends from 185mm - 285mm



Item	Code
Dudley Beta+ Bottom Inlet 9" Part 3 Float Valve	327645



COMPLETE REPAIR KITS FOR BOTH LEVER & BUTTON OPERATED TOILET CISTERNS

INLET VALVES // WASHROOM FILL & FLUSH

Universal Syphon Toilet Repair Kit

- Complete with:
 - ~ Compact Turbo Edge
 - ~ Hydroflo Compact Brass Telescopic Bottom Inlet Valve
 - ~ Chrome Plated front flushing Cistern Lever
- Retrofits on to all existing Dudley downlegs from 7½" to 10"
- Height adjustable from 7½" (191mm) to 9½" (241mm)
- Professional ½" brass tail with water saving delay fill
- Supplied with Chrome Plated front flushing Cistern Lever

Universal Flush Valve Toilet Repair Kit

- Complete with:
 - ~ Victoria Flush Valve with long life silicon rubber seal
 - ~ Hydroflo Compact Brass Telescopic Bottom Inlet Valve
 - ~ Contains all CC connections required
- Victoria Cable allows button to be located on front & top of cistern
- Supplied with adaptor for 51mm (2") outlet; 38mm (1½") outlet
- Chrome plated push button with water saving full & reduced flush
- Telescopic height adjustment 203 (8") - 292mm (11½")

Item	Code
Universal Syphon Toilet Repair Kit	372687
Universal Flush Valve Toilet Repair Kit	372686

04 Outlet Valves



Victoria™ 3 in 1 Dualflush Outlet Valves

OUTLET VALVES // WASHROOM FILL & FLUSH

Cable Operated

- Fitted with a stylish chrome pushbutton that sits neatly in to the lid of the cistern, or in to the front lever hole of the cistern
- 325648 [300mm] comes with 42mm [1.1/2"] outlet tail, supplied with adaptor for a 51mm [2"] outlet
- 375036 [470mm] suitable for 2" outlet
- Available with cable lengths for 300mm long [for close coupled cisterns] and 470mm long [for concealed cisterns]

Mechanical Operated

- Suitable for all top button activated cisterns with 2" outlet
- Attractive chrome plated pushbutton
- High performance 2" outlet
- Adjustable internal overflow from 180mm to 280mm
- Easy pushbutton rod length adjustment

Lever Operated

- Cable operation allows lever to be located on front or side of cistern
- Attractive chrome plated lever handle
- 300mm cable length
- 38mm [1.1/2"] outlet
- Supplied with adaptor for 51mm [2"] outlet

Visit our website for Outlet Valves



COMES WITH THE NEW VALVE MATE AS STANDARD

Simplify your system 3 Valves in 1. Retrofits: Dudley Victoria | FM Pro550 | WQ Kayla

Every Victoria outlet valve now comes with our all **NEW Valve Mate adaptor**, making it easy to retrofit to existing valve cages without dismantling the cistern.



- Time Saving; no need to dismantle
- Retrofit in under 30 seconds
- Inside & outside of cistern assembly

Item	Code
Cable Operated - 300mm cable length	325648
Long Cable Operated - 470mm cable length	375036
Mechanical Operated	373328
Lever Operated	373332

Outlet Valves 04

NIAGARA® MECHANICAL DUALFLUSH VALVE WASHROOM FILL & FLUSH // OUTLET VALVES

Ideal replacement for most toilet valves.

- Long-life silicon rubber seal
- 51mm [2"] outlet
- WRAS approved. 6 / 4 litre dual flush
- Top flush
- Serviced in under 5 mins
- Chrome push button



Item	Code
Niagara Mechanical Dualflush Valve	313348

NIAGARA® PNEUMATIC DUALFLUSH VALVE WASHROOM FILL & FLUSH // OUTLET VALVES

Ideal as a replacement in most concealed cisterns.

- 6 / 4 Litre dualflush and 6 Litre single flush
- 51mm [2"] outlet
- Fitted with a long-life silicon rubber seal
- Can be operated by a wide range of Dudley push buttons, push plates and electronic sensors [sold separately]
- Niagara pneumatic tubes supplied
- Supplied as standard in Vantage, Miniflo and Royal cisterns



Item	Code
Niagara Pneumatic Dualflush Valve	327628

UNIVERSAL FLUSH VALVE TOILET REPAIR KIT

WASHROOM FILL & FLUSH // OUTLET VALVES

Complete repair kit for button operated toilet cisterns.

- Complete with:
 - Victoria Flush Valve with long life silicon rubber seal
 - Hydroflo Compact Brass Telescopic Bottom Inlet Valve
 - All CC connections required to fully refurbish your cistern



Item	Code
Universal Flush Valve Toilet Repair Kit	372686

For available buttons please see pages 24-27

05 Syphons



Turbo Edge Quantum Push Button Syphon

SYPHONS // WASHROOM FILL & FLUSH

Our most advanced syphon yet, ideal as a leak free, push-button replacement for valve-operated systems. Compatible with all Dudley two-piece syphons

- Leak-Free Valve Replacement
- User-friendly light-touch operation
- Water saving Duoflush as standard. Press and hold for full flush, press and release for reduced flush.
- Pair with the Dudley Hydroflo® inlet valve for enhanced water savings - delay fill ensures the cistern only refills after flushing is complete, reducing unnecessary water use
- 6/7/9 litre volume adjustment guaranteeing optimum flush performance
- Perfect for use in close-coupled toilets to replace existing flush valves
- Height adjustable from 7½" (191mm) to 9½" (241mm)
- Comes with both low profile chrome flush buttons and palm push button to suit your preference
- Supplied with adaptor for 51mm (2") outlet
- Fully captive yellow fixing pin does not need to be removed to install syphon, easing installation
- Suitable for Cistern Internal Height: Min: 350mm - Max: 425mm
- Suitable for Water Level: Min: 170mm - Max: 220mm
- 10 Year Warranty

THE BEST PERFORMING SYPHON THAT FITS ALL CISTERNS



Push button operation with a choice of caps; low profile and palm push

The **Turbo Edge Quantum** represents the next evolution in Dudley flushing technology - our most advanced syphon yet, engineered as a leak-free, push-button upgrade for traditional valve-operated systems. Designed for seamless compatibility with all Dudley two-piece syphons, it delivers precision performance, long-term reliability, and effortless installation.

LEAK-FREE VALVE REPLACEMENT

Visit our website for Turbo Edge Quantum



Type	Code
Turbo Edge Quantum Push Button Syphon	377390

Syphons 05



Quantum The World's first Push Button Syphon

SYPHONS // WASHROOM FILL & FLUSH

The Dudley Quantum is a ground-breaking all new Pushbutton Operated Leak-Free Syphonic Toilet Flush Valve. This state-of-the-art product represents a significant leap forward in toilet flushing technology, offering unparalleled efficiency, reliability, and water conservation.

- Innovative pushbutton operation with a mechanically activated syphon, comes equipped with a user-friendly pushbutton mechanism [available in various styles]
- Leak-Free syphonic technology designed and engineered in the UK in order to eliminate leaks and minimise water wastage
- The leak-free design enhances the durability of the valve and contributes to water conservation efforts as Thomas Dudley is committed to sustainability
- Optimises water usage by eliminating leaks without compromising performance
- Easy installation and maintenance
- Crafted from high-quality materials
- Reliable and cost-effective choice for residential and commercial applications



Push button operation with a choice of caps; flush, low profile and palm push

- Syphons use a unique water lift mechanism, moving water upward before gravity takes over, ensuring a leak-free flush
- No dynamic seal beneath the waterline; eliminating the primary cause of leaks and promoting water conservation

Product	Code
Quantum	375252

Visit our website for Syphons

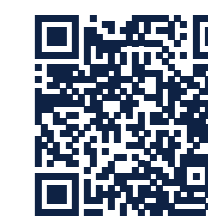



TURBO EDGE® ADJUSTABLE SYPHON

SYPHONS // WASHROOM FILL & FLUSH

Dudley's Turbo Edge® is the world's most compact LEAK-FREE syphon

- Dudley's Turbo Edge is the world's most compact syphon, guaranteed to fit more places than any others
- 6/7/9 Litre volume adjustment guaranteeing optimum flush performance
- Fully captive yellow fixing pin does not need to be removed to install syphon, easing installation.
- It has a 2-part design that enables the syphon body to be simply removed from the cistern leaving the white downleg in position. This feature enables the Turbo Edge to be serviced in under 5 minutes without disconnecting water supply and dismantling cistern
- Retro fits Dudley downlegs from 7½" to 10"
- The Turbo Edge is the ONLY syphon you will ever need for lever operated toilets
- Fits all syphon flush ceramic and plastic WC cisterns
- Includes an internal overflow

Type	Code
Turbo Edge® Adjustable Syphon	370873



TURBO 88™ FIXED HEIGHT

SYPHONS // WASHROOM FILL & FLUSH

The Turbo 88™ is an ideal replacement for syphons in most lever operated cisterns

- Duoflush water-saving feature. This delivers a water-saving reduced flush when the cistern lever is depressed and held down
- When the lever is depressed and released, the Turbo 88™ Duoflush delivers a full flush that is as reliable every time
- Internal overflow (Only if the Correct Height of Syphon is Used, within the Cistern)
- Compatible in most lever operated cisterns

Size	Code
7"	313826
7½"	316965
8"	313639
8½"	319023
9"	315293
9½"	313673
10"	313879



TURBO 88™ ADJUSTABLE

SYPHONS // WASHROOM FILL & FLUSH

The Turbo 88™ Adjustable is an adjustable syphon suitable for most lever operated cisterns

- Duoflush water-saving feature. This delivers a reduced flush when the cistern lever is depressed and held down
- It has a 2-part design that enables the syphon body to be simply removed from the cistern leaving the white downleg in position. This feature enables the Turbo 88™ to be serviced in under 5 minutes without disconnecting water supply and dismantling cistern
- 1½" [38mm] diameter outlet
- 6/7/9 Litre Convertible
- Fully adjustable from 7½" to 9.5"
- Retro fits Dudley downlegs from 7½" to 10"
- Compatible with most low-level lever operated cisterns
- Includes an internal overflow

Item	Code
Turbo 88™ Adjustable	324395



CASCADE+ SYPHON

SYPHONS // WASHROOM FILL & FLUSH

Compact one piece syphon that delivers exceptional flushing performance

- Suitable for low level use
- 6/7/9 litre convertible allowing flush to be configured
- Internal overflow (Only if the Correct Height of Syphon is Used within the Cistern)
- 1½" [38mm] BSP outlet
- Can be used with a variety of different levers

Size	Code
7"	334642
7½"	334643
8"	334644
8½"	334645
9"	334607
9½"	334646

05 Syphons



TURBO 44

SYPHONS // WASHROOM FILL & FLUSH

A WRAS approved 9 litre 2-part syphon. Suitable for high and low level use

- It has a 2-part design that enables the syphon body to be simply removed from the cistern leaving the white downleg in position. This feature enables the Turbo 44 to be serviced in under 5 minutes without disconnecting water supply and dismantling cistern
- The Turbo 44 has been designed specifically to suit narrow cisterns
- Internal overflow (Only if the Correct Height of Syphon is Used, within the Cistern)
- 38mm [1.½"] Outlet
- Compatible in most lever operated cisterns. Specifically suited to narrow cisterns

Size	Code	Size	Code
8"	313326	10"	316300
8.½"	318546	10.½"	319200
9"	315749	11"	319764
9.½"	313970	11.½"	316943



S9 HI-FLO

SYPHONS // WASHROOM FILL & FLUSH

A WRAS approved one-piece syphon. 6/7/9 Litre Convertible.

The S9 Hi-Flo provides a reliable toilet syphon replacement for most high-level and low-level applications.

- 6/7/9 Litre One Piece Syphon
- 32mm [1.½"] Outlet
- Other sizes available please enquire
- Compatible in most low-level lever operated cisterns.
- Internal overflow (Only if the Correct Height of Syphon is Used, within the Cistern)

Size	Code
7.½"	317963
8"	315308
9"	313553



Syphons 05



Turbo S1-11

A WRAS APPROVED 7 OR 9 LITRE 2-PART SYPHON. IDEAL FOR WELL-BOTTOMED CISTERNS

- Compatible in most high-level lever operated cisterns. Specifically suited well-bottomed cisterns
- Internal overflow (Only if the Correct Height of Syphon is Used, within the Cistern)

Size/Outlet	Code
9" Brass (Rubberline)	317449
9" Plastic (Rubberwell)	318743



Universal Syphon Toilet Repair Kit

COMPLETE REPAIR KIT FOR LEVER OPERATED TOILET CISTERNS

- Complete with:
 - Compact Turbo Edge that will fit in more places than any other syphon
 - Hydroflo Compact Brass Telescopic Bottom Inlet Valve
 - Chrome Plated Front Flushing Cistern Lever

Item	Code
Universal Flush Valve Toilet Repair Kit	372687



AUTO SYPHONS

SYPHONS // WASHROOM FILL & FLUSH

Our WRAS approved Auto Syphons have been available for over 30 years and have built an enviable reputation for both quality and reliability. This has resulted in their specification by many large OEM's for use in their own cisterns.

When it comes to controlling the flushing of urinals, the Auto Syphon is still the most inexpensive, trouble-free and simple to install product on the market.

- Easily controlled to minimise water usage
- Requires NO electricity supply
- Requires virtually no maintenance
- Simple to install

Designed to cater for the varied flushing requirements of large and small urinal w.c installations of all types conform to BS 1876 and are available in two outlet sizes:

- 1" [25mm] BSP
- 1.¼" [32mm] BSP

All Auto Syphons are supplied complete with two rubber washers & back nut and is fully tested before leaving the factory.

Can be used in conjunction with other products in our range:

- Sparge Pipes [Page 118]
- Spreaders [Page 118]
- Brackets [Page 104]
- Pet Cock [Page 102]
- Kinetic Range of Washroom Water Controls [Page 62]
- Urinal Wastes [Page 90]

Size/Flushing Height	Code
140mm (5.½") - 1" BSP	364932
140mm (5.½") - 1.¼" BSP	325939
159mm (6.¼") - 1" BSP	364944
159mm (6.¼") - 1.¼" BSP	364947
191mm (7.½") - 1" BSP	364948
191mm (7.½") - 1.¼" BSP	364953
210mm (8.¼") - 1" BSP	364955
210mm (8.¼") - 1.¼" BSP	364958
235mm (9.¼") - 1" BSP	364959
235mm (9.¼") - 1.¼" BSP	364963

06 Toilet Cisterns // Concealed



eco-cistem™

TOILET CISTERNS // WASHROOM FILL & FLUSH

eco-cistem™ in partnership with Thomas Dudley. The first cistern to re-use condensate from air-conditioners to provide free water to flush toilets.

- 485mm [W] x 476mm [H] x 195mm [D]
- Water saving
- Patented chamber design for enhanced performance
- Compatible with grey water input for eco-efficiency
- Pneumatic activation
- Adjustable flush volumes between 6L and 3.½L
- Supplied with 600mm plastic air tube
- Supplied with 2" – 1.½" flush pipe
- Supplied Wall/frame mounting brackets
- Dual fixing points allowing front or rear fixing
- An extensive range of pushbuttons, push plates and touch-free sensors - allows for full customisation to suit any aesthetic or specification
- The first and only cistern to give BREEAM credits and LEED points



• Combines sustainable design with smart functionality

eco-cistem® uses the condensation produced by air conditioning units to flush toilets.

Engineered to integrate seamlessly with fitted furniture, tiles, and various partitioning materials, these cisterns support wall-mounted, frame-mounted, and fully concealed installations, and are compatible with both wall-hung and floor-mounted WCs.

Tailored for a wide array of environments - hotels, offices, residential buildings, retail spaces, leisure centres, and anywhere with air conditioning.

Size	Code
eco-cistem®	377372

Visit our website for Cisterns

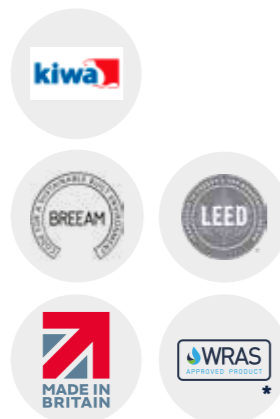

Toilet Cisterns // Concealed 06

DUDLEY MINIFLO™ COMFORT HEIGHT TOILET CISTERNS // CONCEALED

High quality compact comfort height concealed cistern. Designed to fit into smaller spaces.

- 411mm [W] x 276mm [H] x 131mm [D]
- Top Access
- Air tubes enable button, plate or sensor to be installed up to 250mm away from cistern
- Compact dimensions enables the cistern to fit neatly into 150mm ducts
- Internal overflow warning
- Fitted with Hydroflo Side Inlet and Niagara Pneumatic Valve Options Available; Bottom Inlet, Single Flush, Buttons, Plates & Electroflo
- For other variations please contact us



Item	Code
Dudley Miniflo™ Concealed Cistern	333996

DUDLEY MIRAGE™ TOILET CISTERNS // CONCEALED

Concealed cistern fitted with vandal resistant stops.

- 505mm [W] x 285mm [H] x 146mm [D]
- 6/7 Litre convertible
- Top Access
- Levers are fitted with vandal-resistant stops to prevent them being rotated backwards
- Internal overflow warning
- WRAS Approved Dudley Part 3 Side Inlet Valve and Dudley Cascade+ Syphon
- Fitted with Kit W Extended Lever
- Options Available: Bottom Inlet, Turbo Edge®/88 Syphon, Kit P, Kit A, Kit B, Dimple Kit W, Cistern Only, please enquire



Item	Code
Dudley Mirage™ Concealed Cistern	316399

DUDLEY PHANTOM® TOILET CISTERNS // CONCEALED

Concealed cistern with top access & internal overflow warning

- 420mm [W] x 300mm [H] x 150mm [D]
- Top Access
- Levers are fitted with vandal-resistant stops to prevent them being rotated backwards
- Internal overflow warning
- WRAS Approved Dudley Part 3 Side Inlet Valve and Dudley Cascade+ Syphon
- Fitted with Kit W Extended Lever
- Other Options Available: Pneumatic / XLT Cistern, Bottom Inlet, Turbo 88 Syphon, Kit P, Kit A, Kit B, Dimple Kit W, Cistern Only, please enquire



Item	Code
Dudley Phantom® Concealed Cistern [side inlet, lever operated]	315863
Dudley Phantom® Concealed Cistern [bottom inlet, lever operated]	317985
Dudley Phantom® Concealed Cistern (Pneumatic/XLT)	327060

Approved fittings

For all cisterns with electroflo option available please see page 47 for more information
For all cistern spares please see pages 182-184

06 Toilet Cisterns // Concealed



Dudley Vantage

TOILET CISTERNS // WASHROOM FILL & FLUSH

High quality concealed cistern designed specifically for use in bathroom furniture

- 460mm [W] x 369mm [H] x 125mm [D]
- Fitted with integral isolating valve & internal overflow warning
- Air tubes enable button, plate or sensor to be installed up to 250mm away from cistern
- Front & Top Access panels
- Compact dimensions enables the Dudley Vantage to fit neatly into furniture units as small as 500mm [W] x 200mm [D] x 800mm [H]
- Fitted with Hydroflo Side Inlet, Niagara Pneumatic Valve & Dio Button
- Available with ½" brass tail water supply connection*
- Other Options Available: Insulation Jacket, Single Flush, 73.5mm Button, Piazza Button, Royal Button, Oyster Plate, Reef Plate Coral Plate, Electroflo & more
- Vantage cisterns are available with a Type AB weir overflow (Fluid Category 5 Compliant)
- For other variations please contact us

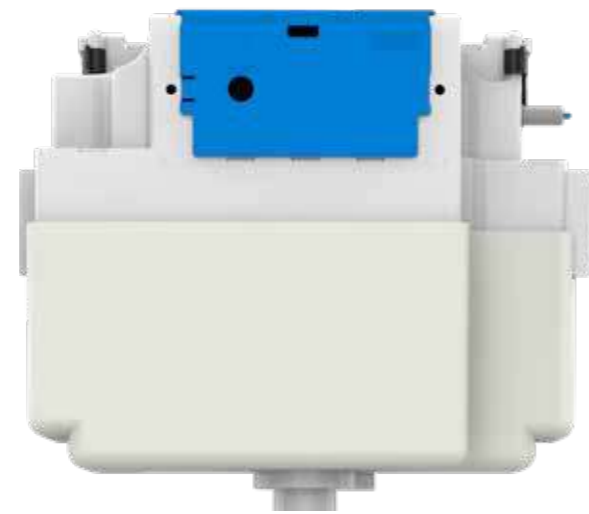

Thomas Dudley manufactures a market-leading range of high quality concealed cisterns. These are perfect for use in all domestic and commercial applications and can be used with confidence in fitted furniture or behind tiles and most partitioning materials. A vast range of pushbuttons, push plates, levers and touch-free electronic sensors is available to provide the perfect finishing touch to any project. The Vantage has been designed specifically for use in bathroom furniture. It is ideal for use behind tiles and partitioning and in most other concealed applications. Available in multiple specifications. Please contact us for more information.

- Front and top access panels
- Compact dimensions
- The Dudley Vantage is available in multiple specification options

Size	Code
Dudley Vantage® Concealed Cistern [no jacket]	313330
Dudley Vantage® Concealed Cistern [with jacket]	320433



Toilet Cisterns // Concealed 06

DUDLEY PUSHFLO® TOILET CISTERNS // CONCEALED

Compact concealed cistern, ideal for use behind tiles and partitioning.

- 420mm [W] x 300mm [H] x 150mm [D]
- Can be either side or bottom inlet
- Air tubes enable button to be installed up to 250mm away from cistern
- Compact dimensions fits neatly into most ducts
- Internal overflow warning
- Fitted with WRAS approved Inlet Valve & Pinto Valve & single flush Cone Button
- Options Available: Bottom Inlet, Dome Button, Petite Button, Flat Metal Pushbutton, please enquire



Item	Code
Dudley Pushflo® Concealed Cistern - No Button	315425
Dudley Pushflo® Concealed Cistern - Flat Metal Button	313321
Dudley Pushflo® Concealed Cistern - Flat Metal Button [extended]	324836

DUDLEY OSMO® F1 TOILET CISTERNS // CONCEALED

The World's first front access serviceable syphon cistern

- 390mm [W] x 346mm [H] x 156mm [D]
- For use with WC furniture & IPS panelling
- Fluid category 5 cistern
- Multiple flushing volumes: 6/4, 6/3, 4/2.6 Litre
- Front access
- Fitted with WRAS approved Turbo Edge® syphon & guaranteed to be leak-free
- WRAS approved Hydroflo with compact float & brass tail - fully compliant to BS 1212-4
- Flush handle with dual flush control [sold separately] available in multiple finishes - please enquire



Item	Code
Dudley OSMO® F1 Concealed Cistern (right hand)	371854
Dudley OSMO® F1 Concealed Cistern (left hand)	371855

DUDLEY OSMO® T1 TOILET CISTERNS // CONCEALED

Top access concealed reversible cistern with Axis Technology™

- 550mm [W] x 315mm [H] x 110mm [D]
- Top access with reversible SnapLock lid™
- Reversible cistern body with AXIS Technology™ achieving multiple outlet & inlet options
- Flush Pipe Stability System (FPSS™) with SureLock™ Bracket
- Multiple Flushing Volumes: 6 / 4 - 5 / 3 - 4 / 2.6 Ltr
- Fluid category 5 cistern; the only way to achieve a water regulations compliant cistern in standard height pod shelves
- WRAS approved Niagara pneumatic flush valve and Hydroflo delay-fill inlet valve as standard, Victoria cable flush valve option available



Item	Code
Dudley OSMO® T1 Concealed Cistern (2" centre outlet)	377201
Dudley OSMO® T1 Concealed Cistern (2" offset outlet)	377202

For all cisterns with electroflo option available please see page 54 for more information
For all cistern spares please see pages 182-184

06 Toilet Cisterns // Exposed



Dudley Acclaim

CONTEMPORARY STYLED EXPOSED TOILET CISTERN IDEAL FOR LIGHT TO MEDIUM USE

- 460mm [W] x 343mm [H] x 155mm [D]
- Contemporary Styling
- Fitted with Part 3 Side Inlet and an Internal Overflow Warning
- Cistern body manufactured in high density polystyrene
- Pushbutton operated acclaim also available
- Internal overflow warning
- Fitted with Cascade+ Syphon or Niagara Mechanical Valve
- Other Options Available: Bottom Inlet, High Level, T88 Syphon and Hydroflo
- For other variations please contact us

Outlet/Actuator	Code
Syphon - White Lever	315196
Syphon - Chrome Lever	316015
Valve - Button	319125



Dudley Diplomat

TRADITIONALLY STYLED EXPOSED TOILET CISTERN IDEAL FOR LIGHT TO MEDIUM USE

- 498mm [W] x 295mm [H] x 186mm [D]
- Fitted with Part 3 Side Inlet and an Internal Overflow Warning
- Various fitting options available
- Cistern body manufactured in high density polystyrene
- Fitted with Cascade+ Syphon
- Fitted with White Lever
- Other Options Available: Bottom Inlet, High Level, Turbo 88 and Hydroflo
- For other variations please contact us

Item	Code
Dudley Diplomat - White Lever	319217
Dudley Diplomat - Chrome Lever	372747



Dudley Elite

TRADITIONALLY STYLED EXPOSED TOILET CISTERN IDEAL FOR LIGHT TO MEDIUM USE

- 584mm [W] x 330mm [H] x 140mm [D]
- Fitted with Part 3 Side Inlet and an Internal Overflow Warning
- Various fitting options available
- Cistern body manufactured in high density polystyrene
- Fitted with Cascade+ Syphon
- Fitted with White Lever
- Other Options Available: Bottom Inlet, T88 Syphon, Hydroflo.
- For other variations please contact us

Item	Code
Dudley Elite	319189



Dudley Slimline

TRADITIONALLY STYLED EXPOSED TOILET CISTERN IDEAL FOR LIGHT TO MEDIUM USE

- 505mm [W] x 316mm [H] x 146mm [D]
- Fitted with Part 3 Side Inlet and an Internal Overflow Warning
- Black & white low level models come with white lever as standard. High level options supplied with chain pull
- Various fitting options available
- Fitted with Cascade+ Syphon
- Other Options Available: Bottom Inlet, T88 Syphon, Hydroflo, Black Cistern
- For other variations please contact us

Item	Code
Dudley Slimline - Low Level	315262
Dudley Slimline - High Level	317305



Dudley Tri-Shell Turbo

EXPOSED CISTERN DESIGNED FOR POTENTIAL VANDALISM OR MISUSE

- 516mm [W] x 287mm [H] x 188mm [D]
- Fitted with Part 3 Side Inlet and an Internal Overflow Warning
- Cistern body manufactured using a unique sandwich foam moulding process, which provides unsurpassed strength and durability
- Designed to prevent external condensation
- Fitted with Turbo 88 Syphon
- Fitted with Chrome Plated Metal Lever
- Other Options Available: Bottom Inlet, High Level, Hydroflo, Dimple Lever, Black
- For other variations please contact us

Item	Code
Dudley Tri-Shell Turbo	315754



Dudley Tri-Well Turbo

EXPOSED CHAIN PULL CISTERN DESIGNED FOR POTENTIAL VANDALISM OR MISUSE

- 467mm [W] x 292mm [H] x 243mm [D]
- Fitted with Part 3 Side Inlet and an Internal Overflow Warning
- Cistern body manufactured using a unique sandwich foam moulding process, providing unsurpassed strength & durability
- Designed to prevent external condensation
- Fitted with Turbo S1-11 Syphon
- Fitted with Metal Fulcrum Arm
- Other Options Available: Black, Brass Tailed Syphon Outlet, Pt.2 Brass Ball Valve
- For other variations please contact us

Item	Code
Dudley Tri-Well Turbo	313510

Toilet Cisterns // Auto 06



Dudley Acclaim Auto

EXPOSED AUTOMATIC TOILET CISTERN FINISHED TO A HIGH GLOSS

- 460mm [W] x 343mm [H] x 155mm [D]
- Outlet centre 74mm from wall
- Available in multiple flush volumes
- High-gloss finish in white
- Cistern body in high-impact polystyrene
- Supplied with automatic syphon and petcock
- Can be used in combination with the Dudley Kinetic Infrared Urinal Flush Control (see page 62)
- For other variations please contact us

Item	Code
Acclaim® - Automatic Urinal Flushing Cistern [4.5L]	314934
Acclaim® - Automatic Urinal Flushing Cistern [9L]	314002



Dudley 'D' Auto

EXPOSED AUTOMATIC TOILET CISTERN FINISHED TO A HIGH-GLOSS

- 498mm [W] x 295mm [H] x 186mm [D]
- Outlet centre 93mm from wall
- Available in multiple flush volumes
- High-gloss finish in white or black
- Cistern body manufactured in high impact polystyrene
- Supplied with automatic syphon and petcock
- Black version available
- Can be used in combination with the Dudley Kinetic Infrared Urinal Flush Control (see page 62)
- For other variations please contact us

Item	Code
"D" Auto™ - Automatic Urinal Flushing Cistern - White [4.5L]	317960
"D" Auto™ - Automatic Urinal Flushing Cistern - White [9L]	314825
"D" Auto™ - Automatic Urinal Flushing Cistern - White [13.5L]	317622



Dudley Tri-Shell Heavy Duty Auto

EXCEPTIONALLY STRONG EXPOSED AUTO CISTERN

- 516mm [W] x 287mm [H] x 188mm [D]
- Outlet centre 90mm from wall
- Available in multiple flush volumes
- High-gloss finish in white, other option available: High-gloss black
- Cistern body manufactured using a unique sandwich foam moulding process making it exceptionally strong
- Designed to prevent external condensation
- Supplied with automatic syphon and petcock
- Can be used in combination with the Dudley Kinetic Infrared Urinal Flush Control (see page 62)
- Other variations, please contact us

Item	Code
Tri-Shell Heavy Duty Automatic Urinal Flushing Cistern [4.5L]	315633
Tri-Shell Heavy Duty Automatic Urinal Flushing Cistern [9L]	315651
Tri-Shell Heavy Duty Automatic Urinal Flushing Cistern [13.5L]	314767



Dudley Mirage Concealed Auto

PERFECT FOR USE IN MODERN CONCEALED WASHROOMS

- 505mm [W] x 285mm [H] x 146mm [D]
- Outlet centre 73mm from wall
- Available in multiple flush volumes
- Cistern body in high-impact polystyrene
- Supplied with automatic syphon and petcock
- Can be used in combination with the Dudley Kinetic Infrared Urinal Flush Control (see page 62)
- Other variations, please contact us

Item	Code
Mirage Concealed Automatic Urinal Flushing Cistern [4.5L]	314128
Mirage Concealed Automatic Urinal Flushing Cistern [9L]	318281
Mirage Concealed Automatic Urinal Flushing Cistern [13.5L]	319755

For all cistern spares please see pages 190-192
Dudley automatic cisterns can also be supplied with the Kinetic intelligent urinal control please see page 62

Cisterns // Options // Concealed

Supplied factory assembled with front and top access panels. Single flush (6 litre) or dualflush 6/4 Litre that converts to a 5/3 Litre or 4/2.6 Litre (Button packed with Cistern) 460mm (W) x 369mm (H) x 125mm (D)

Code	Product Name	Option	Description
Dualflush With Polystyrene Insulation Jacket and with:			
320433	Dudley Vantage		No Button
322422	Dudley Vantage		51mm Dio Button
325285	Dudley Vantage		73.5mm Piazza Button
375354	Dudley Vantage		73.5mm Geo Button
326917	Dudley Vantage		Reef Flush Plate
327023	Dudley Vantage		Coral Flush Plate
325040	Dudley Vantage		Pearl Classic Push Plate
326680	Dudley Vantage		Pearl Palm Push Plate
323377	Dudley Vantage		Oyster Push Plate
322892	Dudley Vantage		Electroflo DF Infrared Sensor with 40mm CP Surround - Mains Operated
322890	Dudley Vantage		Electroflo DF Infrared Sensor with 100mm CP Surround - Mains Operated
326922	Dudley Vantage		Wave S1 Electronic Flush Plate - Mains Operated
326936	Dudley Vantage		Wave S2 Electronic Flush Plate - Mains Operated
330791	Dudley Vantage		Wave S3 Electronic Flush Plate - Square Corners
330781	Dudley Vantage		Wave S3 Electronic Flush Plate - Radius Corners
Dualflush Without Polystyrene Insulation Jacket and With:			
313330	Dudley Vantage		No Button
322420	Dudley Vantage		51mm Dio Button
325284	Dudley Vantage		73.5mm Piazza Button
375354	Dudley Vantage		73.5mm Geo Button
323376	Dudley Vantage		Oyster Push Plate
327022	Dudley Vantage		Coral Push Plate
326681	Dudley Vantage		Pearl Palm Push Plate
322893	Dudley Vantage		Electroflo DF Infrared Sensor with 40mm CP Surround - Mains Operated
322891	Dudley Vantage		Electroflo DF Infrared Sensor with 100mm CP Surround - Mains Operated
Single Flush (Button packed with Cistern) With Polystyrene Insulation Jacket and with:			
314454	Dudley Vantage		51mm Royal Chrome Plated Button
325635	Dudley Vantage		51mm Royal Palm Push Button
325287	Dudley Vantage		73.5mm Piazza Button
314408	Dudley Vantage		73.5mm Chrome Plated Round Button
322888	Dudley Vantage		Electroflo Infrared Sensor with 40mm CP Surround - Mains Operated
Single Flush Without Polystyrene Insulation Jacket and With:			
318750	Dudley Vantage		51mm Royal Chrome Plated Button
324600	Dudley Vantage		51mm Royal Palm Push Button
325286	Dudley Vantage		73.5mm Piazza Button
319787	Dudley Vantage		73.5mm Chrome Plated Round Button
320133	Dudley Vantage		Stainless Steel Royal Single Flush Push Button
322887	Dudley Vantage		Electroflo Infrared Sensor with 100mm CP Surround - Mains Operated
322889	Dudley Vantage		Electroflo Infrared Sensor with 40mm CP Surround - Mains Operated
330236	Dudley Vantage		Remora Satin Stainless Steel Single Flush Push Button

Pneumatically operated Cistern with 6/4 litre dualflush. Can be converted to 5/3 or 4/2.6 litre dualflush. Supplied assembled and comes with flushbend, hanging bracket, Hydroflo Inlet and Niagara Outlet Valve - 411mm (W) x 276mm (H) x 131mm (D). (Button packed with Cistern).

Code	Product Name	Option	Description
Dualflush			
322875	Dudley MiniFlo	SISO	Dualflush CP Button (51mm)
322876	Dudley MiniFlo	BIBO	Dualflush CP Button (51mm)
Single Flush			
322878	Dudley MiniFlo	SISO	Single Flush Royal CP Button (51mm)
322879	Dudley MiniFlo	BIBO	Single Flush Royal CP Button (51mm)
324875	Dudley MiniFlo	BIBO	Electroflo Singleflush Infrared Sensor with 100mm CP Surround - Mains Operated
324728	Dudley MiniFlo	SISO	Electroflo Singleflush Infrared Sensor with 100mm CP Surround - Mains Operated
324841	Dudley MiniFlo	SISO	Electroflo DF Infrared Sensor with 40mm CP Surround - Mains Operated
325021	Dudley MiniFlo	SISO	Electroflo DF Infrared Sensor with 100mm CP Surround - Mains Operated
325289	Dudley MiniFlo	SISO	Dualflush CP Piazza Button
325291	Dudley MiniFlo	SISO	Single Flush CP Piazza Button
325447	Dudley MiniFlo	SISO	Single Flush CP Palm Push Button
325802	Dudley MiniFlo	SISO	Dualflush CP Pearl Classic Push Plate
327787	Dudley MiniFlo	SISO	Dualflush CP Dio Button

For more cistern information, please see pages 48-53

Cisterns // Options // Concealed

Concealed slimline plastic Cistern with 6/7 litre convertible syphon - 505mm (W) x 285mm (H) x 146mm (D). Connections can be left or right handed

Code	Product Name	Option	Description
313098	Dudley Mirage	SISO	Mirage Cistern Only - (Without Lever Kit)
319503	Dudley Mirage	BIBO	Mirage Cistern Only - (Without Lever Kit)
315770	Dudley Mirage	SISO	KIT 'A' CP Lever for wall and duct up to 245mm overall (325mm spindle, 260mm bush)
313961	Dudley Mirage	BIBO	KIT 'A' CP Lever for wall and duct up to 245mm overall (325mm spindle, 260mm bush)
317725	Dudley Mirage	SISO	KIT 'B' CP Lever for wall and duct up to 365mm overall (430mm spindle, 368mm bush)
314332	Dudley Mirage	BIBO	KIT 'B' CP Lever for wall and duct up to 365mm overall (430mm spindle, 368mm bush)
316647	Dudley Mirage	SISO	KIT 'P' CP Lever for Cistern fitted immediately behind 12-65mm partition (115mm spindle, 80mm bush)
314994	Dudley Mirage	BIBO	KIT 'P' CP Lever for Cistern fitted immediately behind 12-65mm partition (115mm spindle, 80mm bush)
316399	Dudley Mirage	SISO	KIT 'W' CP Lever for Cistern fitted immediately behind 114mm wall (225mm spindle, 160mm bush)
317251	Dudley Mirage	BIBO	KIT 'W' CP Lever for Cistern fitted immediately behind 114mm wall (225mm spindle, 160mm bush)
316701	Dudley Mirage	SISO	DIMPLE KIT 'W' for easy flushing by the less able CP Lever for cistern fitted immediately behind 145mm wall (225mm spindle, 160mm bush)
317937	Dudley Mirage	BIBO	DIMPLE KIT 'W' for easy flushing by the less able CP Lever for cistern fitted immediately behind 145mm wall (225mm spindle, 160mm bush)

Concealed plastic Cistern with water saving 6/7 litre convertible Duoflush syphon - 420mm (W) x 300mm (H) x 150mm (D). Connection can be left or right handed

Code	Product Name	Option	Description
316709	Dudley Phantom	SISO	Phantom Cistern Only (Without Lever Kit)
319685	Dudley Phantom	BIBO	Phantom Cistern Only (Without Lever Kit)
313867	Dudley Phantom	SISO	Kit 'A' CP Lever for wall and duct up to 245mm overall (325mm spindle, 260mm bush)
317985	Dudley Phantom	BIBO	Kit 'A' CP Lever for wall and duct up to 245mm overall (325mm spindle, 260mm bush)
319721	Dudley Phantom	SISO	Kit 'B' CP Lever for wall and duct up to 365mm overall (430mm spindle, 368mm bush)
314013	Dudley Phantom	BIBO	Kit 'B' CP Lever for wall and duct up to 365mm overall (430mm spindle, 368mm bush)
315563	Dudley Phantom	SISO	KIT 'P' CP Lever for cistern fitted immediately behind 12-65mm partition (155mm spindle, 80mm bush)
319758	Dudley Phantom	BIBO	KIT 'P' CP Lever for cistern fitted immediately behind 12-65mm partition (155mm spindle, 80mm bush)
315863	Dudley Phantom	SISO	Kit 'W' CP Lever for cistern fitted immediately behind 145mm wall (225mm spindle, 160mm bush)
313088	Dudley Phantom	BIBO	Kit 'W' CP Lever for cistern fitted immediately behind 145mm wall (225mm spindle, 160mm bush)

Concealed 6 or 7 litre plastic Cistern with Dudley Pinto pneumatic flushvalve - 420mm (W) x 300mm (H) x 150mm (D). Connection can be left or right handed

Code	Product Name	Option	Description
320267	Dudley Pushflo	SISO	Cistern with Petite Button
314197	Dudley Pushflo	SISO	Cistern with Dome Button
319409	Dudley Pushflo	SISO	Cistern with Cone Button
324836	Dudley Pushflo	SISO	LL 6L with 'Pinto' Pneumatic Single Flush Valve and Extended Flat Metal Vandal Resistant Push Button
320507	Dudley Pushflo	BIBO	Cistern with Petite Button
317950	Dudley Pushflo	BIBO	Cistern with Dome Button
315076	Dudley Pushflo	BIBO	Cistern with Cone Button
319312	Dudley Pushflo	BIBO	Cistern with Flat Metal VR Button

Concealed 6 or 7 litre plastic Cistern with Dudley Niagara pneumatic flushvalve - 420mm (W) x 300mm (H) x 150mm (D). Connection can be left or right handed

Code	Product Name	Option	Description
318552	Dudley Royal Pushflo	SISO	Cistern with Royal Pushbutton
324204	Dudley Royal Pushflo	SISO	Cistern with Palm Pushbutton
323986	Dudley Royal Pushflo	SISO	LL 6L with 'Niagara' Pneumatic Single Flush Valve and Stainless Steel Ext. Royal Push Button
313922	Dudley Royal Pushflo	BIBO	Cistern with Royal Pushbutton
324205	Dudley Royal Pushflo	BIBO	Cistern with Palm Pushbutton

For more cistern information, please see pages 48-53

Cisterns // Options // Exposed

Plastic Cistern with water saving 6/4 litre convertible Duoflush syphon - 460mm (W) x 343mm (H) x 155mm (D). Connections can be left or right handed

Code	Product Name	Option	Description
317712	Dudley Acclaim 'S'	SISO	H/L White
315196	Dudley Acclaim 'S'	SISO	L/L White (with white Front Lever)
316015	Dudley Acclaim 'S'	SISO	L/L White (with white Front Lever)
313397	Dudley Acclaim 'S'	BIBO	H/L White
314328	Dudley Acclaim 'S'	BIBO	L/L White (with white Front Lever)

Plastic Cistern with 6/4 litre dualflush Dudley Niagara valve with CP top push button

Code	Product Name	Option	Description
319125	Dudley Acclaim V	SISO	L/L White
314488	Dudley Acclaim V	BIBO	L/L White

Plastic Cistern with water saving 6/7/9 litre convertible Duoflush syphon - 498mm (W) x 295mm (H) x 186mm (D)

Code	Product Name	Option	Description
318229	Dudley Diplomat	SISO	H/L (with reversible LH or RH)
319217	Dudley Diplomat	SISO	L/L (with White Front Lever)
316733	Dudley Diplomat	BIBO	H/L (with reversible LH or RH)
319640	Dudley Diplomat	BIBO	L/L (with White Front Lever)

Plastic Panel Cistern with water saving 6/7 litre convertible Duoflush syphon - 584mm (W) x 330mm (H) x 140mm (D). Connections can be left or right handed

Code	Product Name	Option	Description
319189	Dudley Elite	SISO	L/L White (with White Front Lever)
318491	Dudley Elite	BIBO	L/L White (with White Front Lever)

Plastic multi-purpose Cistern with water saving 6/7 litre convertible Duoflush syphon - 505mm (W) x 316mm (H) x 146mm (D). Connection can be left or right handed

Code	Product Name	Option	Description
315262	Dudley Slimline	SISO	L/L (with White Front Lever) - White
313280	Dudley Slimline	BIBO	L/L (with White Front Lever) - White

Sandwich foam heavy duty plastic Cistern with water saving 6/7/9 litre convertible Dudley syphon - 516mm (W) x 287mm (H) x 188mm (D)

Code	Product Name	Option	Description
317978	Dudley Tri-Shell Turbo	SISO	H/L with Turbo 88 single flush 2-part 6/7/9L convertible syphon and reversible LH or RH Chain Pull - White
319617	Dudley Tri-Shell Turbo	SISO	H/L with Turbo 88 single flush 2-part 6/7/9L convertible syphon and reversible LH or RH Chain Pull - Black
315754	Dudley Tri-Shell Turbo	SISO	L/L with Turbo 88 Duoflush 2-part 6/7/9L convertible syphon - White
314289	Dudley Tri-Shell Turbo	SISO	L/L with Turbo 88 Duoflush 2-part 6/7/9L convertible syphon - Black
314218	Dudley Tri-Shell Turbo	BIBO	H/L with Turbo 88 single flush 2-part 6/7/9L convertible syphon and reversible LH or RH Chain Pull - White
313491	Dudley Tri-Shell Turbo	BIBO	H/L with Turbo 88 single flush 2-part 6/7/9L convertible syphon and reversible LH or RH Chain Pull - Black
318021	Dudley Tri-Shell Turbo	BIBO	L/L with Turbo 88 Duoflush 2-part 6/7/9L convertible syphon - White
319457	Dudley Tri-Shell Turbo	BIBO	L/L with Turbo 88 Duoflush 2-part 6/7/9L convertible syphon - Black

Sandwich foam heavy duty well-bottom Cistern with Turbo S1-11, 2 part 6/7/9 litre convertible syphon - 467mm (W) x 292mm (H) x 243mm (D)

Code	Product Name	Option	Description
313510	Dudley Tri-Well Turbo	SISO	H/L with plastic outlet and nuts and reversible LH or RH Chain Pull - White
315207	Dudley Tri-Well Turbo	SISO	H/L with plastic outlet and nuts and reversible LH or RH Chain Pull - Black
313810	Dudley Tri-Well Turbo	SISO	H/L with brass outlet and nuts and reversible LH or RH Chain Pull - White
319868	Dudley Tri-Well Turbo	SISO	H/L with brass outlet and nuts and reversible LH or RH Chain Pull - Black

For more cistern information, please see pages 48-53

Cisterns // Options // Auto

Thermoplastic Automatic Cistern - 460mm (W) x 343mm (H) x 155mm (D)

Code	Product Name	Option	Description
314934	Dudley Acclaim Auto	White	4.5 Litre (1 Gallon)
314002	Dudley Acclaim Auto	White	9.0 Litre (2 Gallon)

Thermoplastic Automatic Cistern - 498mm (W) x 295mm (H) x 186mm (D)

Code	Product Name	Option	Description
317960	Dudley 'D' Auto	White	4.5 Litre (1 Gallon)
319337	Dudley 'D' Auto	Black	4.5 Litre (1 Gallon)
314825	Dudley 'D' Auto	White	9.0 Litre (2 Gallon)
314698	Dudley 'D' Auto	Black	9.0 Litre (2 Gallon)
314494	Dudley 'D' Auto	White	13.5 Litre (3 Gallon) (1" Outlet)
318580	Dudley 'D' Auto	Black	13.5 Litre (3 Gallon)
317622	Dudley 'D' Auto	White	13.5 Litre (3 Gallon) (1.1/4" Outlet)

Sandwich foam heavy duty plastic Automatic Cistern - 516mm (W) x 287mm (H) x 188mm (D)

Code	Product Name	Option	Description
315633	Dudley Tri-Shell Auto	White	4.5 Litre (1 Gallon)
318283	Dudley Tri-Shell Auto	Black	4.5 Litre (1 Gallon)
315651	Dudley Tri-Shell Auto	White	9.0 Litre (2 Gallon)
315023	Dudley Tri-Shell Auto	Black	9.0 Litre (2 Gallon)
314767	Dudley Tri-Shell Auto	White	13.5 Litre (3 Gallon)
313244	Dudley Tri-Shell Auto	Black	13.5 Litre (3 Gallon)

Concealed thermoplastic Automatic Cistern - 505mm (W) x 285mm (H) x 146mm (D)

Code	Product Name	Option	Description
314128	Dudley Mirage Auto		4.5 Litre (1 Gallon)
318281	Dudley Mirage Auto		9.0 Litre (2 Gallon)
319755	Dudley Mirage Auto		13.5 Litre (3 Gallon)



For more cistern information, please see pages 48-53

07 Touch Free



Electroflo® Contemporary™ Tap

TOUCH FREE // WASHROOM FILL & FLUSH

Touch-Free Contemporary Tap

- Stylish tubular design
- Hygienic touch-free operation
- Robust brass body
- Attractive chrome plated, stainless steel or black finishes are available
- Delivers cold or premixed warm water
- Shuts off when hand is removed from in front of sensor
- Water delivery automatically stops after 90 seconds
- Pre-fitted with 5LPM flow regulator, other options available please see table below
- Suitable for pressures of 0.5-8.0 bar + with flow restrictor
- 50-300mm sensor range
- 316G Stainless Steel version available

Finish/Power	Flow Regulator	Code
Polished Chrome – Mains	5LPM	323681
Polished Chrome – Battery	5LPM	323680
Stainless Steel Effect – Mains	5LPM	327965
Matt Black – Mains	5LPM	327966
Polished Chrome – Mains	1.75LPM	377420
Stainless Steel Effect – Mains	1.75LPM	377418
Matt Black – Mains	1.75LPM	377416
Polished Chrome – Mains	3.75LPM	377421
Stainless Steel Effect – Mains	3.75LPM	377419
Matt Black – Mains	3.75LPM	377417

Visit our website for Touch-Free



Our Dudley Electroflo Contemporary Tap is a vanity top/basin mounted electronic tap. Ideal for use in most domestic and commercial applications. Its contemporary design will improve the look of any washroom. Delivers as little as 1 litre of water per visit.

- Stylish tubular design
- Hygienic touch-free operation



Polished Chrome Stainless Steel Effect Matt Black

Touch Free // Soap Dispensers 07

ELECTROFLO® CONTEMPORARY™ SOAP DISPENSER

TOUCH FREE // WASHROOM FILL & FLUSH

Touch-Free Contemporary™ Soap Dispenser and Hand Sanitiser

- Stylish tubular design
- Hygienic touch-free operation
- Robust brass body
- Attractive chrome plated, stainless steel or black finishes are available
- 1 litre capacity
- 50mm – 300mm sensor range
- Suitable for soap and hand sanitiser with viscosities of 0 to 3800cps



Polished Chrome Stainless Steel Effect Matt Black

Finish/Power	Code
Polished Chrome – Mains	324327
Polished Chrome – Battery	326437
Stainless Steel Effect – Mains	327974
Matt Black – Mains	327975

ELECTROFLO® HORIZON™ SOAP DISPENSER

TOUCH FREE // WASHROOM FILL & FLUSH

Touch-Free Horizontal™ Soap Dispenser and Hand Sanitiser

- Minimalistic design
- Hygienic touch-free operation
- Robust brass body
- Attractive chrome plated, stainless steel or black finishes are available
- 1 litre capacity
- 50mm – 300mm sensor range
- Suitable for soap and hand sanitiser with viscosities of 0 to 3800cps

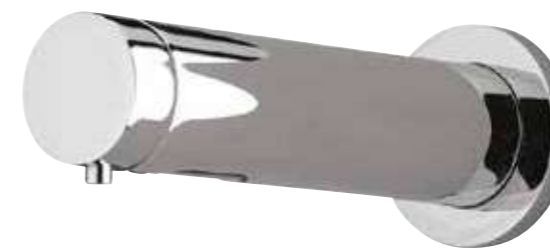

Polished Chrome Stainless Steel Effect Matt Black

Finish/Power	Code
Polished Chrome – Mains	325423
Polished Chrome – Battery	325424
Stainless Steel Effect – Mains	327976
Matt Black – Mains	327977

07 Touch Free // Taps



ELECTROFLO® HORIZON TAP

TOUCH FREE // WASHROOM FILL & FLUSH

Touch-Free Horizon Tap

- Minimalistic design
- Hygienic touch-free operation
- Delivers cold or premixed warm water
- Shuts off when hand is removed from in front of sensor
- Water delivery automatically stops after 90 seconds
- Suitable for pressures of 0.5-8.0 bar + with flow restrictor
- 50mm – 300mm sensor range
- Supports BREEAM
- Pre-fitted with 5LPM flow regulator, other options available please see table below

Finish/Power	Flow Regulator	Code
Polished Chrome – Mains	5LPM	324329
Polished Chrome – Battery	5LPM	324328
Stainless Steel Effect – Mains	5LPM	327968
Matt Black – Mains	5LPM	327969
Polished Chrome – Mains	1.75LPM	377426
Stainless Steel Effect – Mains	1.75LPM	377424
Matt Black – Mains	1.75LPM	377422
Polished Chrome – Mains	3.75LPM	377427
Stainless Steel Effect – Mains	3.75LPM	377425
Matt Black – Mains	3.75LPM	377423

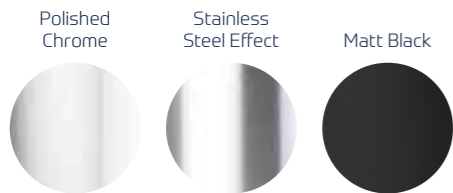

Touch Free // Taps 07



ELECTROFLO® LINEAR TAP

TOUCH FREE // WASHROOM FILL & FLUSH

Touch-Free Linear Tap

- Minimalistic design
- Hygienic touch-free operation
- Delivers cold or premixed warm water
- Shuts off when hand is removed from in front of sensor
- Water delivery automatically stops after 90 seconds
- Suitable for pressures of 0.5-8.0 bar + with flow restrictor
- 50mm – 300mm sensor range
- Supports BREEAM
- Pre-fitted with 5LPM flow regulator

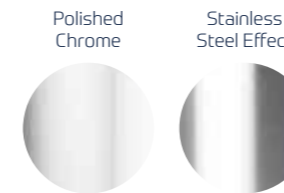

Finish/Power	Code
Polished Chrome – Mains	323685
Polished Chrome – Battery	323684
Stainless Steel Effect – Mains	327967



ELECTROFLO® ARC TAP

TOUCH FREE // WASHROOM FILL & FLUSH

Touch-Free Arc tap

- Classic Swan Neck design
- Hygienic touch-free operation
- Delivers cold or premixed warm water
- Shuts off when hand is removed from in front of sensor
- Water delivery automatically stops after 90 seconds
- Suitable for pressures of 0.5-8.0 bar + with flow restrictor
- Pre-fitted with 5LPM flow regulator

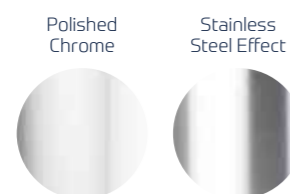

Finish	Code
Polished Chrome - Mains	327972
Stainless Steel Effect - Mains	327973



ELECTROFLO® AVANTI TAP

TOUCH FREE // WASHROOM FILL & FLUSH

Touch-Free Avanti Tap

- Sleek minimalistic design
- Hygienic touch-free operation
- Delivers cold or premixed warm water
- Shuts off when hand is removed from in front of sensor
- Water delivery automatically stops after 90 seconds
- Suitable for pressures of 0.5-8.0 bar + with flow restrictor
- 50mm – 300mm sensor range
- Supports BREEAM
- Pre-fitted with 5LPM flow regulator, other options available please see table below

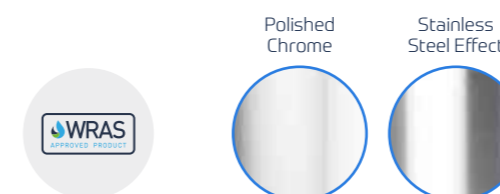

Finish/Power	Flow Regulator	Code
Chrome - Mains	5LPM	326400
Stainless Steel Effect - Mains	5LPM	326575
Polished Chrome – Mains	1.75LPM	377430
Stainless Steel Effect – Mains	1.75LPM	377428
Polished Chrome – Mains	3.75LPM	377427
Stainless Steel Effect – Mains	3.75LPM	377431



07 Touch Free // Urinal Controls



KINETIC® INFRARED URINAL FLUSH CONTROL

TOUCH FREE // WASHROOM FILL & FLUSH

Dudley Kinetic® intelligent multi urinal flush control

- Ideal for use with automatic cisterns and multiple station urinals
- Can be easily installed into pipework, wall or ceiling mounted applications
- Supplied with an aesthetically pleasing flush mounting kit
- Each unit can be powered by mains, 4 x AA batteries or mains with battery backup (batteries not included)
- Control box can be installed remotely from the solenoid and is supplied as standard with a 1m cable
- Can be serviced without removing the Kinetic controller and opening the Kinetic valve
- Passive infrared sensor detects user movement. After a pre-set time, the solenoid valve allows water to fill the cistern and deliver a flush
- Fast fill reduces scale build up
- Suitable for water pressures ranging from 0.1 bar to 10 bar
- Quick and simple set up via user-friendly buttons and intuitive software without having to continually refill and empty the automatic cistern
- 12 hour hygiene and 24 hour economy flushing modes can also be quickly configured to customer requirements
- Tamper proof design and chrome fittings are conveniently included
- Control box dimensions: 118mm(h) x 118mm(w) x 33mm(d)
- Solenoid box dimensions: 98mm(h) x 100mm(w) x 50mm(d)
- Regulates flushing based on actual washroom usage to save up to 80% of water when compared to traditional systems

Finish	Code
White/White	327877
Grey/Grey	327878

Kinetic Package Options

Includes: Kinetic in White/White, 9L Dudley 'D' Auto Cistern, 2pc Sparge Pipe Set & Top Inlet Spreaders	330273
Includes: Kinetic in White/White, 13.5L Dudley 'D' Auto Cistern, 3pc Sparge Pipe Set & Top Inlet Spreaders	330274
Includes: Kinetic in White/White, 9L Dudley 'Tri-Shell' Auto Cistern, 2pc Sparge Pipe Set & Top Inlet Spreaders	330277



Can be used in conjunction with other products in our range, please see page 118

Touch Free // Urinal Controls // WC Controls 07

ELECTROFLO® TOUCH FREE URINAL SENSOR

TOUCH FREE // WASHROOM FILL & FLUSH

Touch Free Flushing For Direct Flush Urinal Systems

- Provides touch free flushing for direct flush urinal systems
- Flow time is programmable from 1 – 20 seconds, using optional remote control
- Adjustable flow rate and flush time
- Suitable for pressures of 0.3-8.0 bar
- Sensor is supplied with solenoid valve
- Can be supplied with Dudley DC Pipe Interrupter - 327995 (air gap) to achieve fluid category 5 back flow prevention
- Can be set to automatic 24 hour hygiene flush



Finish/Power	Code
Chrome – Mains	323687
Chrome – Battery [9V]	323686
Stainless Steel Effect – Mains	327979
Matt Black – Mains	333959

ELECTROFLO® TOUCH FREE WC KIT

TOUCH FREE // WASHROOM FILL & FLUSH

Touch Free Flushing For Concealed Cisterns

- Dual flush functionality can deliver 6/4, 5/3 or 4/2.6 litre flush volumes
- Ø40mm IR sensor available in chrome and matt black finishes or machined 304 stainless steel
- Ø100mm IR sensor includes instructional graphics
- Sensor detects a plurality of hand gestures; wave for full flush, hold hand in front of sensor for reduced flush
- LED flush indication
- Post flush sensor delay allows the cistern to refill before another flush can be delivered
- Control box can be integrally mounted with the sensor at the rear of the panel or independently mounted onto a suitable flat surface



Finish/Power/Size	Code
Stainless Steel – Mains – 40mm	371959
Matt Black – Mains – 40mm	372097
Chrome – Mains – 40mm	333388
Chrome – Mains – 100mm	372172

07 Touch Free // Accessories

THERMOSTATIC MIXING VALVE

TOUCH FREE // WASHROOM FILL & FLUSH

Thermostatic Mixing Valves meet the requirement of BS7942: 2000 and NHS D08.

- Perfect for use with Dudley Electroflo Taps
- Can be used with pressures of 0.2 - 10 bar
- Delivers water between 30° and 50°
- Integral check valves and filters
- Available in 15mm and 22mm



Size	Code
15mm	324551
22mm	324552

TAP JUNCTION BOX

TOUCH FREE // WASHROOM FILL & FLUSH

The Dudley Tap Junction Box is perfect for powering up to 10 Electroflo Taps

- Two and Three way male to female and female to male power splitters available



Item	Code
Tap Junction Box	323691

Resan Sanitaryware // WC Pans & Toilets 08

RESAN® WC PAN - STANDARD HEIGHT

RESAN SANITARYWARE // WC PANS & TOILETS

Anti-Ligature & Damage Resistant Toilet Pan Standard Height with Polished Resin for Gloss Effect

- Anti-Ligature and damage resistant
- Standard white WC pans are cast in a single piece, reducing join joints which are difficult to clean and enhancing strength
- The waste spigot height is 180mm
- Contrasting colour integral seats are available with a range of Resan WC Pans
- Non-Flammable – BS476 Pt 6 & 7 Class '0' and Class '1'
- ISO EN 19712-3-2007 Rated 5 for durability, stain resistance and cigarette burns
- BS EN 997 6/4 Litre and 5/3 Flush Approval
- BS EN 33:2019 WC pans and WC suites- Connecting Dimensions
- Supports requirements of WAT 01 BREEAM
- UK Ministry Of Justice Safer Cell Approved [Bolt to wall only]



Resan Pan - Standard Height

Fitting	Finish	Seat	Code
Bolt To Floor	Polished Resin	Plain Seat Open Rim	334084
Bolt To Floor	Polished Resin	Blue Seat Open Rim	334085
Bolt To Floor	Polished Resin	Grey Seat Open Rim	375048
Bolt To Wall	Polished Resin	Plain Seat Open Rim	334077
Bolt To Wall	Polished Resin	Blue Seat Open Rim	334086
Bolt To Wall	Polished Resin	Grey Seat Open Rim	375047

- Damage Resistant

- Anti-Ligature

Visit our website for Resan Sanitaryware



08 Resan Sanitaryware // WC Pans & Toilets



RESAN RESAN® WC PAN - LESS ABLED

RESAN SANITARYWARE // WC PANS & TOILETS

Anti-Ligature and Damage Resistant Toilet Pan for Less Able with Polished Resin for Gloss Effect

- Anti-Ligature & damage resistant
- Suitable for public washrooms which must conform to Approved Document M as well as environments such as Care Homes and Disabled Washroom facilities
- This raised height WC is considered as 'comfort height' being 480mm high rather than the standard 415mm
- Standard white WC pans are cast in a single piece, reducing join joints which are difficult to clean & enhancing strength
- Contrasting colour integral seats are available with a range of Resan WC Pans
- The waste spigot height is 283mm
- Extension Box **NOT** fitted as standard, can be provided which extends the projection of the pan out from the wall to 750mm from the standard 500mm
- Non-Flammable – BS476 Pt 6 & 7 Class '0' and Class '1'
- ISO EN 19712-3-2007 Rated 5 for durability, stain resistance and cigarette burns
- BS EN 997 6/4 Litre and 5/3 Flush Approval
- Supports requirements of WAT 01 BREEAM
- UK Ministry Of Justice Safer Cell Approved [Bolt to wall only]

Resan Pan - Less Aabled

Fitting	Finish	Seat	Code
Bolt to Floor	Polished Resin	Plain	372561
Bolt to Floor	Polished Resin	Plain Blue	372562
Bolt to Floor	Polished Resin	Plain Grey	372563
Bolt to Wall	Polished Resin	Plain	372558
Bolt to Wall	Polished Resin	Plain Blue	372559
Bolt to Wall	Polished Resin	Plain Grey	372560
Extension Box Only			372564



RESAN® WC PAN - STANDARD HEIGHT - WITH SEAT FIXING HOLES

RESAN SANITARYWARE // WC PANS & TOILETS

Damage Resistant Toilet Pan Standard Height with Polished Resin for Gloss Effect - With Seat Fixing Holes

- Damage resistant
- Standard white WC pans are cast in a single piece, reducing join joints which are difficult to clean and enhancing strength
- The waste spigot height is 180mm
- Seat is **NOT** included but is available with this model [375059]
- Contrasting colour integral seats are available with a range of Resan WC Pans.
- Non-Flammable – BS476 Pt 6 & 7 Class '0' and Class '1'
- ISO EN 19712-3-2007 Rated 5 for durability, stain resistance and cigarette burns
- BS EN 997 6/4 Litre and 5/3 Flush Approval
- BS EN 33:2019 WC pans and WC suites- Connecting Dimensions
- Supports requirements of WAT 01 BREEAM
- UK Ministry of Justice Safer Cell Approval [Bolt to wall only]

Resan Pan - Standard Height - With Seat Fixing Holes

Fitting	Finish	Fixing	Code
Bolt To Wall	Polished Resin	Seat Fixing Holes	334080
Bolt To Floor	Polished Resin	Seat Fixing Holes	334082

Seat Option

Item	Code
Emerald Standard Close Toilet Seat & Cover with Metal Top Fix Hinge	375059

Resan Sanitaryware // WC Pans & Toilets 08



RESAN® LEFT HAND WC CORNER PAN - STANDARD HEIGHT

RESAN SANITARYWARE // WC PANS & TOILETS

Anti-Ligature and Damage Resistant Left Hand Corner Toilet Pan Standard Height with Polished Resin for Gloss Effect

- Anti-Ligature & damage resistant
- Designed for seatless use and prevents hidden corners
- Concealed through-wall services and fixings
- Standard white WC pans are cast in a single piece, reducing join joints which are difficult to clean & enhancing strength
- The waste spigot height is 180mm (BS EN 33)
- Other contrasting colour integral seats are available with a range of Resan WC Pans
- Non-Flammable – BS476 Pt 6 & 7 Class '0' and Class '1'
- ISO EN 19712-3-2007 Rated 5 for durability, stain resistance and cigarette burns
- BS EN 997 6/4 Litre and 5/3 Flush Approval
- BS EN 33:2019 WC pans and WC suites- Connecting Dimensions
- Supports requirements of WAT 01 BREEAM
- UK Ministry of Justice Safer Cell Approval

Resan Left Hand WC Corner Pan - Standard Height

Fitting	Finish	Seat	Code
Bolt To Wall	Polished Resin for Gloss Effect	Plain Seat Open Rim	374586
Bolt To Wall	Polished Resin for Gloss Effect	Blue Seat Open Rim	375034
Bolt To Wall	Polished Resin for Gloss Effect	Grey Seat Open Rim	375044



RESAN® RIGHT HAND WC CORNER PAN - STANDARD HEIGHT

RESAN SANITARYWARE // WC PANS & TOILETS

Anti-Ligature and Damage Resistant Right Hand Corner Toilet Pan Standard Height with Polished Resin for Gloss Effect

- Anti-Ligature & damage resistant
- Designed for seatless use and prevents hidden corners
- Concealed through-wall services and fixings
- Standard white WC pans are cast in a single piece, reducing join joints which are difficult to clean & enhancing strength
- The waste spigot height is 180mm (BS EN 33)
- Contrasting colour integral seats are available with a range of Resan WC Pans
- Non-Flammable – BS476 Pt 6 & 7 Class '0' and Class '1'
- ISO EN 19712-3-2007 Rated 5 for durability, stain resistance and cigarette burns
- BS EN 997 6/4 Litre and 5/3 Flush Approval
- BS EN 33:2019 WC pans and WC suites- Connecting Dimensions
- Supports requirements of WAT 01 BREEAM
- UK Ministry Of Justice Safer Cell Approved

Resan Right Hand WC Corner Pan - Standard Height

Fitting	Finish	Seat	Code
Bolt To Wall	Polished Resin for Gloss Effect	Plain Seat Open Rim	375035
Bolt To Wall	Polished Resin for Gloss Effect	Blue Seat Open Rim	375045
Bolt To Wall	Polished Resin for Gloss Effect	Grey Seat Open Rim	375046

08 Resan Sanitaryware // Sinks & Basins

Optional Waste Grille available



NEW



Resan® Inset Basin

A HIGHLY ROBUST ANTI-LIGATURE BASIN

- Anti-Ligature & damage resistant basins, ideal for use in all applications where there may be the potential for vandalism, heavy treatment or misuse
- Fits where space is at a premium and where enhance anti-ligature qualities are required
- Cast in a single piece with no join joints
- Used in combination with our Washroom Control System [374572] which can manage activation run times, purges and lock out management
- Water flow can be activated using Infra-red, Piezo or Pneumatic controls, sold separately - please see page 71
- Easily renewable surface - no gel coat
- Optional waste grille [375052]
- Non-Flammable - BS476 Pt 6 & 7 Class '0' & Class '1'
- ISO EN 19712-3-2007 Rated 5 for durability, stain resistance and cigarette burns

Product	Code
Inset Basin for use with Infra-red Piezo Controls [sold separately]	374585
Inset Basin for use with Pneumatic Controls [sold separately]	375256
Resan Anti-Ligature Waste Grille	375052

Resan® Anti-Ligature Basin

WITH NOSE AND TAP OUTLETS

- Anti-Ligature & damage resistant basins, ideal for use in all applications where there may be the potential for vandalism, heavy treatment or misuse
- Water flow can be activated using Infra-red, Piezo or Pneumatic controls, sold separately - please see page 71
- Easily renewable surface - no gel coat
- Back to wall design allows all pipework to be safely concealed
- Sensors | buttons can be used in through-wall applications up to 300mm thick when using extension piece
- Non-Flammable - BS476 Pt 6 & 7 Class '0' & Class '1'
- ISO EN 19712-3-2007 Rated 5 for durability, stain resistance and cigarette burns
- UK Ministry Of Justice Safer Cell Approved
- BS EN 14688:2015 Sanitary appliances. Wash basins. Functional requirements & test methods

Product	Code
Nose & x2 Tap Outlet: Infra-red Piezo Controls [sold separately]	374417
Nose & x1 Tap Outlet: Right Hand Infra-red Piezo Controls [sold separately]	374418
Nose & x1 Tap Outlet: Left Hand Infra-red Piezo Controls [sold separately]	374419
Nose & x2 Tap Outlet: Pneumatic Controls [sold separately]	333883
Nose & x1 Tap Outlet for: Right Hand Pneumatic Controls [sold separately]	370950



Resan® Oval Basin

A WALL FIXED BASIN, NO OVERFLOW

- Damage resistant basins, ideal for use in all applications where there may be the potential for vandalism, heavy treatment or misuse
- Back to wall design can be mounted using our bespoke fixing bracket [333413]
- Range of activation and control options available, please enquire
- Non-Flammable - BS476 Pt 6 & 7 Class '0' and Class '1'
- ISO EN 19712-3-2007 Rated 5 for durability, stain resistance and cigarette burns

Product	Code
Oval - Centre Hole Basin	333973
Oval - x2 Hole Basin	330813
Cast Iron Fixing Bracket - see page 73	333413
Oval Basin Waste Extended Tail 1.1/4" - see page 73	368161

Resan® Rectangular Basin

DAMAGE RESISTANT RECTANGULAR BASIN

- Ideal for use in all applications where there may be the potential for vandalism, heavy treatment or misuse
- Back to wall design allows all pipework to be safely concealed
- Range of activation & control options available, please enquire
- Non-Flammable - BS476 Pt 6 & 7 Class '0' & Class '1'
- ISO EN 19712-3-2007 Rated 5 for durability, stain resistance and cigarette burns

Product	Code
Rectangular Basin	330812

Resan Sanitaryware // Urinal Units // Mirror Frames & Shelving 08



RESAN® URINAL

RESAN SANITARYWARE // URINAL UNITS

Damage Resistant Urinal

- Anti-Ligature & damage resistant which is ideal for use in all applications where there may be the potential for vandalism, heavy treatment or misuse
- Suitable for use with direct flush controls or automatic urinal flushing with Kinetic®
- It is important when using a direct flush system that a DC Pipe Interrupter is fitted to comply with Water Regulations
- Can be teamed with water-saving electronic urinal controls that support BREEAM and other initiatives'
- Back to wall design allows all pipework to be safely concealed
- Bespoke colours and designs can be supplied subject to sufficient demand
- Non-Flammable - BS476 Pt 6 & 7 Class '0' and Class '1'
- ISO EN 19712-3-2007 Rated 5 for durability, stain resistance and cigarette burns

Product	Code
Resan Urinal	325601



Resan® Mirror Frame

ANTI-LIGATURE MIRROR FRAME SYSTEM

- Damage resistant & anti-ligature ideal for use alongside Resan sanitaryware where there may be the potential for vandalism, heavy treatment or misuse
- 3mm thick tough polycarbonate that's vandal & scratch resistant while also not flexing easily. Important for dementia sufferers as well as custodial applications where weaponising of a broken product must be avoided
- Solution for vandal proof restroom mirror, industrial & other high footfall requirements where the unit is subject to damage & vandalism
- Available in 2 sizes [350 x 450mm] and [600 x 500mm]
- Non-Flammable - BS476 Pt 6 & 7 Class '0' and Class '1'
- ISO EN 19712-3-2007 Rated 5 for durability, stain resistance and cigarette burns
- UK Ministry Of Justice Safer Cell Approved

Product	Code
Resan Mirror 350 x 450mm - Rear Fixed	326147
Resan Mirror 500 x 600mm - Rear Fixed	334297
Resan Mirror 350 x 450mm - Front Fixed	371636
Resan Mirror 500 x 600mm - Front Fixed	374414



Resan® Shelf

DAMAGE RESISTANT, ANTI-LIGATURE SHELF

- Anti-ligature and damage resistant
- Ideal for use in conjunction with Resan sanitaryware to create damage resistant installations in all commercial applications
- Bespoke colours and designs can be supplied subject to sufficient demand
- Can be both rear and front fixed
- UK Ministry Of Justice Safer Cell Approved

Product	Code
Resan Shelf - Rear Fixed	326144
Resan Shelf - Front Fixed	331493

08 Resan Sanitaryware // Intelligent Controls



RESAN® WASHROOM CONTROL SYSTEM

RESAN SANITARYWARE // INTELLIGENT CONTROLS

Introducing the **NEW Dudley Resan® Washroom Control System** with 4 channels, intended primarily to control a single washroom's water outlets for use in specialist custodial and healthcare applications.

- A complete washroom water management system that allows control of any combination of hot and cold taps, shower outlet and WC
- Activation of all controls using either infra-red sensors or piezo buttons
- Visual display for easy programming with tactile program buttons
- Programmable run time of hot & cold taps and showers
- Programmable lock out to prevent misuse of all outlets
- Programmable manual and automatic purge and chlorination cycle
- Remote key switch option available for out of room washroom shut off [374579]
- UKCA/CE Marked



Product	Code
Washroom Control System only	374572

- Washroom Control Kit 1 - Piezo Controls c/w:**
- > Washroom Control System
 - > Input and Output Extension Cables
 - > x1 Blue Piezo Touch Control, x2 Red Piezo Touch Control, x1 Silver Piezo Touch Control
 - > WC Cistern Interface Control
 - > x3 Solenoid Valves

- Washroom Control Kit 2 - Infra-red Sensor Controls c/w:**
- > Washroom Control System
 - > Input and Output Extension Cables
 - > x1 Blue Infra-red Sensor, x2 Red Infra-red Sensor, x1 Silver Infra-red Sensor
 - > WC Cistern Interface Control
 - > x3 Solenoid Valves



Resan Sanitaryware // Intelligent Controls 08

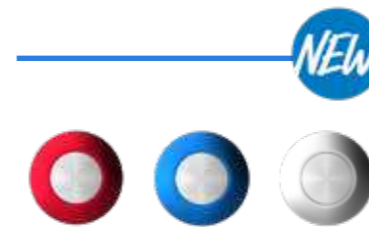

Resan® Piezo Control Kit

TOUCH CONTROLS DESIGNED FOR USE WITH TAPS, SHOWER & WC

- Used in combination with our Washroom Control System
- 2 buttons for use with taps, Hot [red] Cold [blue]
- 1 button for use with taps, shower & WC
- Colour coded surrounds: Hot [red] Cold [blue] for taps, Pre-mixed [red as standard] for single tap or shower and Silver for WC
- Anti-ligature design
- Programmable run time and lock-out function available

Item	Code
Piezo Controls - 1 Button [Blue]	384594
Piezo Controls - 1 Button [Red]	374593
Piezo Controls - 1 Button [Silver]	374595

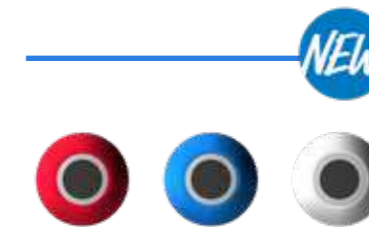

Resan® Infra-Red Sensor Control Kit

TOUCH-FREE INFRARED CONTROLS DESIGNED FOR USE WITH TAPS, SHOWER & WC

- Used in combination with our Washroom Control System
- 2 Sensors for use with taps, Hot [red] Cold [blue]
- 1 Sensor for use with taps, shower & WC
- Colour coded surrounds: Hot [red] Cold [blue] for taps, Pre-mixed [red as standard] for single tap or shower and Silver for WC
- Anti-ligature design
- Hygienic touch-free operation
- Programmable run time, sensor range and lock-out function available

Item	Code
Infra-red Controls - 1 Sensor [Blue]	374613
Infra-red Controls - 1 Sensor [Red]	374596
Infra-red Controls - 1 Sensor [Silver]	374614



Resan® Wash Basin Control Set

PNEUMATIC ANTI-VANDAL BASIN CONTROLS

- Through-the-wall control set for vandal resistant wash basins. For use in healthcare and secure sectors
- 3 sizes available to suit a range of wall thicknesses
- Vandal-resistant robust construction
- Anti-ligature design
- Stainless steel surround
- Anodised colour coded push buttons
- Supplied with pneumatic solenoid valve (½" BSP)
- Adjustable automatic shut-off

Item	Code
Resan Pneumatic Control for walls <20mm	332825
Resan Pneumatic Control for walls <115mm	326185
Resan Pneumatic Control for walls <240mm	327822



Resan® WC Cistern Interface Control

WC FLUSH INTERFACE UNIT

- Used in combination with our Washroom Control System
- Converts the 12V DC output from the Resan Control Via the designated button or sensor into a Pneumatic output controlling the Full or partial flush of our Vantage, Miniflo or Phantom V Concealed cisterns
- No additional power supply required

Item	Code
Resan WC Cistern Control	374580



Resan® Shower Control

VANDAL RESISTANT PNEUMATIC THROUGH THE WALL CONTROL

- Through-wall control set for vandal resistant shower systems. For use in healthcare & secure sectors
- Vandal resistant robust construction
- Anti-ligature design
- Stainless steel surround
- Supplied with solenoid valve (½" BSP)

Item	Code
Resan Shower Control	326186



Resan® Control Extension Kit

STEEL WITH A BRASS CONNECTING COLLAR

- To suit installation up to 200mm and 300mm thick

Item	Code
Resan Control Extension Kit 100mm	374575
Resan Control Extension Kit 200mm	374576

08 Resan Sanitaryware // Intelligent Controls // Options

NEW



Resan® Basin & Shower Solenoid Valve Kit

- Used for controlling the water supplies to the Shower and Hot & Cold taps
- Activation via Piezo touch button or infrared sensor
- Supplied with FI to 15mm compression fittings and includes 4m Output Cable
- Fasten Electrical Terminal connections for ease of installation
- No polarity on Electrical Terminal connections
- It is recommended that the inline filter supplied is fitted to the inlet of the valve. Please note direction of flow

Item	Code
Resan Basin & Shower Solenoid Valve Kit	374578

NEW



Resan® WC Direct Flush Valve Kit

- For use with our Washroom Control System for full flush control without a concealed cistern
- Piezo touch button or infrared activation
- Programmable single or dual flush
- Supplied with pipe interrupter, fittings, accessories and 4m output cable
- Fasten electrical terminals for quick installation
- No polarity on Electrical Terminal connections
- Minimum 100 LPM flow rate; pre-fitted flow regulator manages higher flow
- WRAS approved solenoid valve
- Resan flushpipe available 610mm [24"] x 610mm [24"] x 38mm, can be cut down to length on the horizontal length, (vertical not recommended)

Item	Code
Resan WC Direct Flush Valve Kit	374577
Resan® PVC Flushpipe	363703

NEW



1/2" Socket

Resan® Basin Sensor Sleeve Extension

- SUITABLE FOR WALLS UP TO 140mm THICK
- To suit walls up to 140mm thick
- For walls greater than 140mm thick use 1/2" socket

Item	Code
Resan® Basin Sensor Sleeve Extension	370997
Resan® 1/2" Socket	369159

NEW

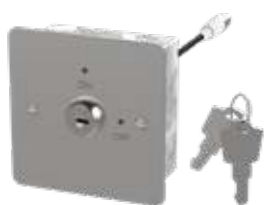

Resan® Remote Key Switch

- BRUSHED STAINLESS STEEL FINISH
- Available if required for isolation of all functionality of the washroom control system - can be operated remotely & securely
- This Key operated switch is mounted into a flat Stainless steel plate which is printed 'ON and OFF' and is suitable for installation to a standard 1 Gang Metal, Dry-line or Patress box
- Comes with a 1 gang x 35mm deep metal clad patress box, with two switch plate mounting screws and two keys
- The auxiliary input cable is 4M long
- Keys are universal across all switches

Item	Code
Resan Remote Key Switch	374579

NEW



Resan® Extension Cable

- INPUT | OUTPUT 4M
- All IR sensors and Piezo touch buttons come with a 500mm long cable and a 4M input extension cable, this is so that the IR sensor or Button can be replaced without having to trace back and remove the whole cable back to the control unit
- It is recommended that any cabling either input or output does not exceed 8M

Item	Code
Resan Input Extension Cable [white]	374581
Resan Output Extension Cable [black]	374582



Resan® Wall Shower Head

- VANDAL RESISTANT ANTI-LIGATURE WALL MOUNTED SHOWER HEAD
- Fixed wall mounted shower head for use with walls up to 230mm thick
- Automatic flow rate regulation
- Anti-ligature design
- Scale-resistant
- Adjustable spray nozzle with locking feature
- Concealed fixings
- Systematically drains after use (no water retention or impurity deposits)
- Anti swivel lug

Item	Code
Resan Wall Shower	326183

Resan Sanitaryware // Options 08

NEW



Resan® Ceiling Shower Head

- VANDAL RESISTANT ANTI-LIGATURE CEILING MOUNTED SHOWER HEAD
- Vandal proof, anti-ligature shower for use in the healthcare & secure sector
- Vandal resistant robust construction
- Anti-ligature design
- Stainless steel finish
- Chrome plated brass body
- Other sized tails are available, please enquire

Item	Code
Resan Ceiling Shower	326184



Resan® Anti-Vandal Taps

- NON-CONCUSSIVE RESAN ANTI-VANDAL TAPS
- For prison and custodial applications [HMP Prisons only]
- Deck Mounted
- For use with Resan Oval Basin
- Automatic shut off
- Supplied with hot and cold indices with water flow aerator
- Cartridge PRO-167/C+H/VALVE-C/P
- 1/2" x 50mm threaded tail connections
- Deck mount drill hole dia. 22mm
- Anti-vandal, anti-swivel lug feature
- Min operating pressure 0.2 bar LP

Item	Code
Resan® Anti-Vandal Taps	332920



Vandal Resistant Deck Mounted Dome Head Tap

- STAINLESS STEEL
- Smooth anti-ligature dome head prevents attachment points
- Tamper-resistant flow adjustment via left-hand security ring
- 4mm flow holes for controlled, anti-splash delivery
- 1/2" BSP thread with crush washer for a secure, leak-free seal
- Requires split-ring tool or two-pronged pliers for authorised adjustment
- Compact design fits tight spaces and mounts to any worktop
- Standard stainless-steel finish
- Manufactured from high-quality materials

Item	Code
Resan® Anti-Vandal Taps	377451



Resan® Oval Basin Waste

- 1 1/4" BSP WASTE FOR RESAN OVAL BASIN
- For use with the Resan® Oval Basin, available in slotted and unslotted
- Chrome plated
- 2 x plugs included
- 2 x back nuts included; chrome plated brass and nylon
- Sealing washer included

Item	Code
Slotted Resan 1 1/4" BSP Waste Extended Tail	332344
Unslotted Resan 1 1/4" BSP Waste Extended Tail	368161

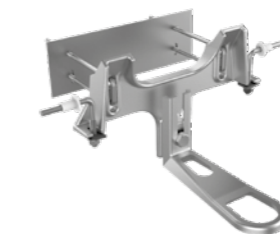

Resan® Oval Basin Bracket

- HEAVY-DUTY CAST IRON BASIN BRACKET
- Heavy-duty mounting bracket for use with the Resan Oval Basin
- Highly robust ductile cast iron construction
- Damage resistant
- Suitable for use with Resan Oval Basin for direct retrofit purposes
- Supplied with through wall fixing kit (Max. Wall Thickness 155mm)
- Galvanised finish
- Height adjustable waste support

Item	Code
Resan Oval Basin Bracket	333413



Waste / Spreader & Trap Kit for Resan® Urinal

- COMPREHENSIVE RANGE OF ACCESSORIES
- Urinal waste 1 1/2" brass body and stainless steel removable dome cover
- Urinal spreader back inlet tail is made from solid brass and head has a smooth chrome finish
- L10 1 1/2" x 75mm seal trap
- Items available to purchase separately please enquire

Item	Code
Waste/Spreader & Trap Kit for Resan Urinal	327395

Plumbing Fittings & Spares

For high-quality plumbing fittings and plumbing spares, you're in the right place. Find exactly the parts you need in record time with our core categories, and you'll be onto the next job in no time.

For live product lead times please visit our website.

Epson



In this section

<p>01 » Bathroom/Kitchen Accessories 76</p> <p>Wastes, Traps & Accessories 76</p> <p>Pan Connectors 84</p> <p>Toilet Seats 100</p> <p>Accessories 101</p> <p>Grab Rails 105</p> <p>Plugs & Chains 106</p>	<p>02 » Cistern Levers & Pulls 109</p> <p>03 » Cistern Tank Fittings 118</p> <p>Syphon and Flush Valve Accessories 118</p> <p>Flushpipe Bends & Accessories 119</p> <p>Close Coupling Kits & Spares 121</p>	<p>04 » Pre-Packed Products 123</p> <p>Plumbing Boxes 123</p> <p>Polybag Range 128</p> <p>05 » Washers & Seals 131</p> <p>Tap 131</p> <p>Toilet Cistern/ Tank 132</p> <p>Trap & Waste 132</p> <p>Central Heating 134</p> <p>Service & Hose 134</p> <p>General 135</p> <p>O Rings 135</p>
--	--	---



Visit our website

Visit our website and search our extensive range of plumbing parts, find key product information such as technical specifications, installation and troubleshooting guides and create your order all in one place using our Quote Builder function.

01 Bathroom/Kitchen Accessories // Wastes, Traps & Accessories



Basin Mate

BATHROOM ACCESSORIES // PLUMBING FITTING & SPARES

Basin Mate Seal Kit - A handy way of sealing your old or new basin waste

- 1.¼" Seal Kit
- Quick and East to Fit
- Saves Time and Money
- No need for Paint, Putty or Mastic

Item	Code
Basin Mate	368148

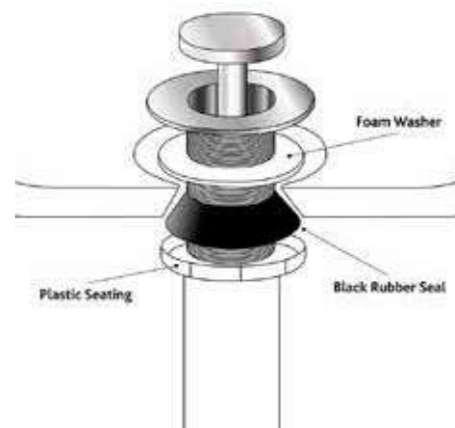

Say goodbye to leaky wastes! Installing basin wastes has never been so easy! Our Basin Mate seal kit is a handy way of sealing your old or new basin waste. The kit is manufactured from high quality materials and includes a sealing ring, washer and seating – everything you need for a quick and easy installation. There is no need for paint, putty or mastic!

- A handy way of sealing your old or new basin waste.
- There is no need for paint, putty or mastic!

Visit our website



Bath/Kit Accessories // Wastes, Traps & Accessories 01



BASIN WASTE WITH LEAK-FREE BASIN MATE

BATHROOM ACCESSORIES // BASIN WASTE

Unslotted Basin Waste with a Square Mushroom Spring Plug and Basin Mate Seal Kit

- High quality chrome plating to BS1224, providing a contemporary yet traditional look
- Ideal replacement for most plastic or ceramic basins
- Manufactured from high quality solid brass
- Supplied with square mushroom spring plug
- Unslotted Design



Item	Code
1.¼" Basin Waste with LEAK-FREE Basin Mate	372467

BASIN WASTE WITH LEAK-FREE BASIN MATE

BATHROOM ACCESSORIES // BASIN WASTE

Slotted with Square Mushroom Spring Plug with Basin Mate Seal Kit

- High quality chrome plating to BS1224, providing a contemporary yet traditional look
- Ideal replacement for most plastic or ceramic basins
- Manufactured from high quality solid brass
- Supplied with square mushroom spring plug
- Slotted design suitable for basins with an overflow



Item	Code
1.¼" Basin Waste with LEAK-FREE Basin Mate	372397

BASIN WASTE WITH LEAK-FREE BASIN MATE

BATHROOM ACCESSORIES // BASIN WASTE

Unslotted with Flip/Swivel Plug with Basin Mate Seal Kit

- High quality chrome plating to BS1224, providing a contemporary yet traditional look
- Ideal replacement for most plastic or ceramic basins
- Manufactured from high quality solid brass
- Supplied with flip/swivel (captive) plug
- Unslotted design



Item	Code
1.¼" Basin Waste with LEAK-FREE Basin Mate	372396

Explore our full range in our Epson Wastes and Accessories brochure - We can supply any waste in any finish.

01 Bathroom/Kitchen Accessories // Wastes, Traps and Accessories

Bath/Kit Accessories // Wastes, Traps & Accessories 01



BASIN WASTE WITH LEAK-FREE BASIN MATE

BATHROOM ACCESSORIES // BASIN WASTE

Slotted with Flip/Swivel Plug with Basin Mate Seal Kit

- High quality chrome plating to BS1224, providing a contemporary yet traditional look
- Ideal replacement for most plastic or ceramic basins
- Manufactured from high quality solid brass
- Supplied with flip/swivel (captive) plug
- Slotted design suitable for basins with an overflow



Item	Code
1.1/4" Basin Waste with LEAK-FREE Basin Mate	372395

BASIN WASTE WITH LEAK-FREE BASIN MATE

BATHROOM ACCESSORIES // BASIN WASTE

Unslotted with Chrome Plug and Chain with Basin Mate Seal Kit

- High quality chrome plating to BS1224, providing a contemporary yet traditional look
- Ideal replacement for most plastic or ceramic basins
- Manufactured from high quality solid brass
- Supplied with chrome plug and chain stay
- Unslotted design



Item	Code
1.1/4" Basin Waste with LEAK-FREE Basin Mate	372392

BASIN WASTE WITH LEAK-FREE BASIN MATE

BATHROOM ACCESSORIES // BASIN WASTE

Unslotted with Mushroom Spring Plug with Basin Mate Seal Kit

- High quality chrome plating to BS1224, providing a contemporary yet traditional look
- Ideal replacement for most plastic or ceramic basins
- Manufactured from high quality solid brass
- Supplied with mushroom spring plug
- Unslotted design



Item	Code
1.1/4" Basin Waste with LEAK-FREE Basin Mate	372394

BASIN WASTE WITH LEAK-FREE BASIN MATE

BATHROOM ACCESSORIES // BASIN WASTE

Unslotted with Spring Clicker and Chain with Basin Mate Seal Kit

- High quality chrome plating to BS1224, providing a contemporary yet traditional look
- Ideal replacement for most plastic or ceramic basins
- Manufactured from high quality solid brass
- Supplied with spring clicker
- Unslotted design



Item	Code
1.1/4" Basin Waste with LEAK-FREE Basin Mate	374826

BASIN WASTE WITH LEAK-FREE BASIN MATE

BATHROOM ACCESSORIES // BASIN WASTE

Slotted with Mushroom Spring Plug with Basin Mate Seal Kit

- High quality chrome plating to BS1224, providing a contemporary yet traditional look
- Ideal replacement for most plastic or ceramic basins
- Manufactured from high quality solid brass
- Supplied with mushroom spring plug
- Slotted design suitable for basins with an overflow



Item	Code
1.1/4" Basin Waste with LEAK-FREE Basin Mate	372393

BASIN WASTE WITH LEAK-FREE BASIN MATE

BATHROOM ACCESSORIES // BASIN WASTE

Slotted with Spring Clicker and Chain with Basin Mate Seal Kit

- High quality chrome plating to BS1224, providing a contemporary yet traditional look
- Ideal replacement for most plastic or ceramic basins
- Manufactured from high quality solid brass
- Supplied with spring clicker
- Slotted design



Item	Code
1.1/4" Basin Waste with LEAK-FREE Basin Mate	374641

Explore our full range in our Epson Wastes and Accessories brochure - We can supply any waste in any finish.

01 Bathroom/Kitchen Accessories // Wastes, Traps and Accessories

Bath/Kit Accessories // Wastes, Traps & Accessories 01



BASIN WASTE WITH LEAK-FREE BASIN MATE

BATHROOM ACCESSORIES // BASIN WASTE

Slotted with Chrome Plug and Chain with Basin Mate Seal Kit

- High quality chrome plating to BS1224, providing a contemporary yet traditional look
- Ideal replacement for most plastic or ceramic basins
- Manufactured from high quality solid brass
- Supplied with chrome plug and chain stay
- Slotted design suitable for basins with an overflow

Item	Code
1.1/4" Basin Waste with LEAK-FREE Basin Mate	372391



BASIN WASTE

BATHROOM ACCESSORIES // BASIN WASTE

Plastic Body and Poly Plug

- Quick and simple installation
- Creates a traditional look for your bathroom
- Slotted type - suitable for basin with overflow
- Unslotted type - suitable for basin without overflow
- Manufactured from high quality materials
- Plastic Body
- Supplied with PVC plug, chain and stay

Item	Code
Slotted 1.1/4" Basin Waste	368154
Unslotted 1.1/4" Basin Waste	368301



BASIN WASTE WITH LEAK-FREE BASIN MATE

BATHROOM ACCESSORIES // BASIN WASTE

Unslotted with Poly Plug and Chain with Basin Mate Seal Kit

- High quality chrome plating to BS1224, providing a contemporary yet traditional look
- Ideal replacement for most plastic or ceramic basins
- Manufactured from high quality solid brass
- Supplied with poly plug and chain
- Unslotted design

Item	Code
1.1/4" Basin Waste with LEAK-FREE Basin Mate	372390



BASIN WASTE

BATHROOM ACCESSORIES // BASIN WASTE

Chrome finish, Brass Body and Spring Clicker

- Quick and simple installation
- Creates a modern look for your bathroom
- Available in either Slotted or Unslotted
- Chrome plated finish - any finish available please enquire
- Manufactured from high quality materials
- Brass Body
- Spring Clicker

Item	Code
1.1/4" Slotted Brass Body	368167
1.1/4" Unslotted Brass Body	368172



BASIN WASTE WITH LEAK-FREE BASIN MATE

BATHROOM ACCESSORIES // BASIN WASTE

Slotted with Poly Plug and Chain with Basin Mate Seal Kit

- High quality chrome plating to BS1224, providing a contemporary yet traditional look
- Ideal replacement for most plastic or ceramic basins
- Manufactured from high quality solid brass
- Supplied with poly plug and chain
- Slotted design suitable for basins with an overflow

Item	Code
1.1/4" Basin Waste with LEAK-FREE Basin Mate	372389



BASIN WASTE

BATHROOM ACCESSORIES // BASIN WASTE

Chrome finish, Brass Body and Poly Plug

- Quick and simple installation
- Creates a traditional look for your bathroom
- Available in either Slotted or Unslotted
- Supplied with PVC plug, chain and stay
- Chrome plated finish - any finish available please enquire
- Brass Body
- Poly Plug

Item	Code
1.1/4" Slotted Brass Body	368165
1.1/4" Unslotted Brass Body	368171

Explore our full range in our Epson Wastes and Accessories brochure - We can supply any waste in any finish.

01 Bathroom/Kitchen Accessories // Wastes, Traps and Accessories



Example
Matt Black Finish



BASIN WASTE

BATHROOM ACCESSORIES // BASIN WASTE Chrome finish, Brass Body and Mushroom Clicker

- Quick and simple installation
- Creates a modern look for your bathroom
- Available in either Slotted or Unslotted
- Chrome plated finish - any finish available please enquire
- Manufactured from high quality materials
- Brass Body
- Mushroom Clicker

Item	Code
1.1/4" Slotted Brass Body	368163
1.1/4" Unslotted Brass Body	368170



Example
Nickel Finish



BASIN WASTE

BATHROOM ACCESSORIES // BASIN WASTE Chrome Finish Brass Body and Flipover

- Quick and simple installation
- Creates a modern look for your bathroom
- Available in either Slotted or Unslotted
- Chrome plated finish - any finish available please enquire
- Extended tail option also available
- Brass Body
- Flip/swivel (captive) plug

Item	Code
1.1/4" Slotted Brass Body	368162
1.1/4" Unslotted Brass Body	368169



BASIN WASTE

BATHROOM ACCESSORIES // BASIN WASTE Chrome finish, Brass Body and Chrome Plug

- Quick and simple installation
- Creates a traditional look for your bathroom
- Available in either Slotted or Unslotted
- Manufactured from high quality material
- Chrome plated finish - any finish available please enquire
- Brass Body
- Supplied with chrome plated plug, chain and stay

Item	Code
Slotted 1.1/4" Basin Waste	368159
Unslotted 1.1/4" Basin Waste	335037

Bath/Kit Accessories // Wastes, Traps & Accessories 01



BASIN WASTE

BATHROOM ACCESSORIES // BASIN WASTE Chrome finish, Brass Body and Captive Plug

- Quick and simple installation
- Creates a traditional look for your bathroom
- Chrome plated finish - any finish available please enquire
- Manufactured from high quality materials
- Slotted Brass Body
- Captive Poly or Chrome Plug

Item	Code
1.1/4" Basin Waste with captive poly plug	335032
1.1/4" Basin Waste with captive chrome plug	368160



Example
Polished Brass Finish



BASIN WASTE

BATHROOM ACCESSORIES // BASIN WASTE Chrome, Brass Body and Square Clicker

- Quick and simple installation
- Creates a traditional look for your bathroom
- Available in either Slotted or Unslotted
- Chrome plated finish - any finish available please enquire
- Manufactured from high quality materials
- Brass Body
- Square Clicker

Item	Code
Slotted 1.1/4" Basin Waste	368166
Unslotted 1.1/4" Basin Waste	335049



BASIN WASTE

BATHROOM ACCESSORIES // BASIN WASTE Vanity Basin Combination Waste

- Quick and simple installation
- Creates a traditional look for your bathroom
- Chrome plated finish - any finish available please enquire
- Slotted Brass Body
- Manufactured from high quality materials
- Brass Body
- Chrome Plug

Item	Code
1.1/4" Basin Waste	368153

Explore our full range in our Epson Wastes and Accessories brochure - We can supply any waste in any finish.

01 Bathroom/Kitchen Accessories // Wastes, Traps and Accessories

BATH WASTE

BATHROOM ACCESSORIES // BATH WASTE

Brass Body and Poly Plug

- Quick and simple installation
- Creates a traditional look for your bathroom
- Chrome plated finish - any finish available please enquire
- Manufactured from high quality materials
- Brass Body
- Poly Plug and ball chain



Item	Code
1.½" Bath Waste	368183

BATH WASTE

BATHROOM ACCESSORIES // BATH WASTE

Brass Body and Chrome Plug

- Quick and simple installation
- Creates a traditional look for your bathroom
- Manufactured from high quality materials
- Chrome plated finish - any finish available please enquire
- Brass Body
- Chrome Plug and ball chain



Item	Code
1.½" Bath Waste	368175

BATH WASTE

BATHROOM ACCESSORIES // BATH WASTE

Combi Plastic Body and Pop Up Waste

- Quick and simple installation
- Creates a modern look for your bathroom
- Chrome plated finish - any finish available please enquire
- Manufactured from high quality materials
- Handy pop up plug – no need to search for the plug at the end of the chain
- Standard and long length cable



Item	Code
1.½" Bath Waste - Standard cable length	368181
1.½" Bath Waste - Long cable length	368327

Bath/Kit Accessories // Wastes, Traps & Accessories 01



BATH WASTE

BATHROOM ACCESSORIES // BATH WASTE

Combi Plastic Body and Mushroom Clicker

- Quick and simple installation
- Creates a modern look for your bathroom
- Spring loaded plug for easy drainage
- Chrome plated finish - any finish available please enquire
- Combi Waste
- Manufactured from high quality materials
- Plastic Body
- Mushroom Clicker



Item	Code
1.½" Bath Waste	368177

BATH WASTE

BATHROOM ACCESSORIES // BATH WASTE

Combi Plastic Body and Chrome Plug

- Quick and simple installation
- Creates a traditional look for your bathroom
- Parking plug design
- Chrome plated finish - any finish available please enquire
- Combi Waste
- Manufactured from high quality materials
- Plastic Body
- Chrome Plug



Item	Code
Bath Waste	368180

BATH WASTE

BATHROOM ACCESSORIES // BATH WASTE

Combi Brass Body and Poly Plug

- Quick and simple installation
- Creates a traditional look for your bathroom
- Chrome plated finish - any finish available please enquire
- Combi Waste
- Overflow
- Manufactured from high quality materials
- Brass Body
- Poly Plug



Item	Code
Bath Waste	368178

Explore our full range in our Epson Wastes and Accessories brochure - We can supply any waste in any finish.

01 Bathroom/Kitchen Accessories // Wastes, Traps and Accessories

BATH WASTE

BATHROOM ACCESSORIES // BATH WASTE

Combi Plastic Body and Poly Plug

- Quick and simple installation
- Creates a traditional look for your bathroom
- Chrome plated finish - any finish available please enquire
- Combi Waste
- Manufactured from high quality materials
- Plastic Body
- Poly Plug



Item	Code
Bath Waste	368179

BATH WASTE

BATHROOM ACCESSORIES // BATH WASTE

Combi Plastic Body and Spring Clicker

- Quick and simple installation
- Creates a modern look for your bathroom
- Spring loaded plug for easy drainage
- Combi Waste
- Manufactured from high quality materials
- Chrome plated finish - any finish available please enquire
- Plastic Body
- Spring Clicker



Item	Code
Bath Waste	368182

BATH WASTE

BATHROOM ACCESSORIES // BATH WASTE

Combi Brass Body and Chrome Plug

- Quick and simple installation
- Creates a traditional look for your bathroom
- Chrome plated finish - any finish available please enquire
- Combi Waste, with overflow
- Manufactured from high quality materials
- Brass Body
- Chrome Plug



Item	Code
Bath Waste	368176

Bath/Kit Accessories // Wastes, Traps & Accessories 01



FLUSH GRATED WASTE

BATHROOM ACCESSORIES // FLUSH GRATED WASTE

Threaded Flush Grated Waste

- Chrome plated finish - any finish available please enquire
- Available in either Slotted or Unslotted
- Manufactured from high quality materials



Thread x Flange Size	Tail	Code
1.¼" x 2.¼"	86mm Solid Tail	368187
1.¼" x 2.¼"	86mm Slotted Tail	368188
1.½" x 2.¼"	83mm Solid Tail	368191
1.½" x 2.¼"	83mm Slotted Tail	368192
1.½" x 2"	38mm Solid Tail	368193
1.½" x 3"	83mm Solid Tail	368195

FLUSH GRATED WASTE

BATHROOM ACCESSORIES // FLUSH GRATED SHOWER WASTE

Flush Grated Waste with Removable Centre/Top

- Quick and simple installation
- Chrome plated finish - any finish available please enquire
- Solid Tailed flush grated waste
- Unslotted
- Manufactured from high quality materials



Thread x Flange Size	Tail	Code
1.½" x 2.¼"	38mm Solid Tail	368190

FLUSH GRATED WASTE

BATHROOM ACCESSORIES // FLUSH GRATED SHOWER WASTE

Flush Grated Waste with Removable Octagonal Centre

- Quick and simple installation
- Chrome plated finish - any finish available please enquire
- Solid Tailed flush grated waste
- Unslotted
- Manufactured from high quality materials



Thread x Flange Size	Tail	Code
1.½" x 2.¼"	38mm Solid Tail	368194
1.½" x 2.¼"	63mm Solid Tail	335137
1.½" x 2.¼"	86mm Solid Tail	368344

Explore our full range in our Epson Wastes and Accessories brochure - We can supply any waste in any finish.

01 Bathroom/Kitchen Accessories // Wastes, Traps and Accessories



SINK WASTE

KITCHEN ACCESSORIES // SINK WASTE

Combi Plastic Body and Poly Plug

- 1.½" Sink Waste
- 18" ball style chain
- Manufactured from high quality materials
- Combi Waste, with round overflow face
- Plastic or brass Body
- Poly Plug

Item	Code
1.½" Sink Waste - plastic body	368200
1.½" Sink Waste - brass body	366534

Bath/Kit Accessories // Wastes, Traps & Accessories 01



BASKET STRAINER WASTE

KITCHEN ACCESSORIES // BASKET STRAINERS

Strainer Waste. White/Stainless Steel

- Quick and simple installation
- Creates a traditional look for your kitchen
- Manufactured from high quality materials
- Basket Strainer
- White or Stainless Steel Pictured - any finish available please enquire

Item	Code
White	368198
Stainless Steel	368196



BELFAST AND LONDON STYLE SINK WASTE

KITCHEN ACCESSORIES // SINK WASTES

Chrome finish Wastes with Poly Plug

- 1.½" Belfast Style [slotted] and London Style [Unslotted] Sink Waste
- Available in either Slotted or Unslotted
- Chrome plated finish - any finish available please enquire
- Brass Body - available with plastic body
- Poly Plug - available with brass plug

Item	Code
Slotted Belfast Waste - Brass Body with poly plug	368201
Unslotted London Waste - Brass Body with poly plug	368203

SINK STRAINER

KITCHEN ACCESSORIES // SINK WASTE

Economy Sink Strainer

- Rust Free
- Aluminium



Item	Code
Economy Sink Strainer	365570



BASKET STRAINER WASTE

KITCHEN ACCESSORIES // BASKET STRAINERS

Strainer Waste with Overflow White/Stainless Steel

- Basket Strainer
- Comes with Overflow
- White/Stainless Steel - any finish available please enquire

Item	Code
White	368199
Stainless Steel	368197

SINK STRAINER

KITCHEN ACCESSORIES // SINK WASTE

Chrome Sink Strainer

- Chrome Flange



Item	Code
Chrome Sink Strainer	365668

Explore our full range in our Epson Wastes and Accessories brochure - We can supply any waste in any finish.

01 Bathroom/Kitchen Accessories // Wastes, Traps and Accessories



- Basin Waste Shroud**
LONG BASIN WASTE UNIVERSAL SHROUD
- To suit slotted or unslotted wastes
 - Any finish available - please enquire

Item	Code
Basin Waste Shroud	368173



- Stainless Steel Urinal Waste**
STAINLESS STEEL REMOVABLE DOME COVER
- Brass Body
 - 3.1/4" Tail Length
 - 2.1/2" Flange Size
 - Any finish available - please enquire

Size	Code
1.1/2"	368205
1.1/2"	368208



- Stainless Steel Urinal Waste**
STAINLESS STEEL WITH HINGED DOME COVER
- Brass Body
 - 3.1/4" Tail Length
 - 2.1/2" Flange Size
 - Any finish available - please enquire

Size	Code
1.1/2"	335139



- Plastic Urinal Waste**
WHITE PLASTIC FIXED DOME TOP
- 2.1/2" Flange Size

Size	Code
1.1/2"	368206
1.1/2"	334609
1.1/4" Short Tail [45mm]	335007
1.1/2" Short Tail [45mm]	368210



- Straight Waste Connector**
EPSON UNIFIX STRAIGHT WASTE CONNECTOR

Size	Code
32mm	368258
38mm	368263



- Obtuse Bend Waste Connector**
EPSON UNIFIX OBTUSE BEND CONNECTOR

Size	Code
32mm	368259
38mm	368264



- 90° Knuckle Bend Waste Connector**
EPSON UNIFIX 90° KNUCKLE BEND CONNECTOR

Size	Code
32mm	368260
38mm	368265



- Reducer Waste Connector**
EPSON UNIFIX REDUCER 38mm TO 32mm

Item	Code
38mm - 32mm	368262



- Waste Connector Coupled Both Ends**
EPSON UNIFIX REDUCER 1.1/2" - 1.1/4"

Item	Code
1.1/2" - 1.1/4" Reducer	368267

Bathroom/Kitchen Accessories // Wastes, Traps and Accessories 01



- P Traps**
MOSTLY USED WITH DOMESTIC AND PROFESSIONAL BASINS
- Quick and easy to fit
 - Manufactured to BS EN274
 - Tubular two piece
 - Supplied with unifix outlet to suit polypropylene, ABS and copper pipe
 - Replacement washers available
 - No solvent welding required
 - Available in a range of sizes and styles

Size	Code
32mm x 38mm Seal	368211
38mm x 38mm Seal	368215
32mm x 75mm Seal	368213
38mm x 75mm Seal	368217
38mm x 38mm Seal Deep Seal Trap with Cleaning Eye	368219



- P Traps for Bath & Showers**
MOSTLY USED WITH DOMESTIC AND PROFESSIONAL BATHS & SHOWERS
- Quick and easy to fit
 - Manufactured to BS EN274
 - One piece
 - Supplied with unifix outlet to suit polypropylene, ABS and copper pipe
 - Replacement washers available
 - No solvent welding required
 - Available in a range of sizes and styles

Size	Code
38mm x 20mm Seal No Cleaning Eye	368235
38mm x 20mm Seal Single Cleaning Eye	368236



- S Traps**
MOSTLY USED WITH DOMESTIC AND PROFESSIONAL BASINS
- Quick and easy to fit
 - Manufactured to BS EN274
 - Tubular two piece
 - Supplied with unifix outlet to suit polypropylene, ABS and copper pipe
 - Replacement washers available
 - No solvent welding required
 - Available in a range of sizes and styles



Size	Code
32mm x 38mm Seal	368212
38mm x 38mm Seal	368216
32mm x 75mm Seal	368214
38mm x 75mm Seal	368218

Explore our full range in our Epson Wastes and Accessories brochure - We can supply any waste in any finish.

01 Bathroom/Kitchen Accessories // Wastes, Traps and Accessories



Running P Trap

MOSTLY USED WITH DOMESTIC AND PROFESSIONAL BASINS

- Quick and easy to fit
- Manufactured to BS EN274
- Tubular two piece
- Supplied with unifix outlet to suit polypropylene, ABS and copper pipe
- Replacement washers available
- No solvent welding required

Size	Code
38mm x 75mm Seal	368252



P Traps with Telescopic Inlets

MOSTLY USED WITH DOMESTIC AND PROFESSIONAL BASINS

- Quick and easy to fit
- Manufactured to BS EN274
- Tubular two piece (180mm Tube)
- Supplied with unifix outlet to suit polypropylene, ABS and copper pipe
- Replacement washers available
- No solvent welding required

Size	Code
38mm x 75mm Seal	368227
38mm x 38mm Seal	368226



Fixed Height Bottle Trap - Anti-Vac

MOSTLY USED WITH DOMESTIC AND PROFESSIONAL BASINS

- Quick and easy to fit
- Manufactured to BS EN274
- Supplied with with adapters & unifix outlet to suit polypropylene, ABS and copper pipe
- Replacement washers available
- Compact
- No solvent welding required

Type	Code
Universal Trap with adaptors	368247



Telescopic Bottle Trap - Anti Vac

MOSTLY USED WITH DOMESTIC AND PROFESSIONAL BASINS

- Quick and easy to fit
- Manufactured to BS EN274
- Supplied with adapters & unifix outlet to suit polypropylene, ABS and copper pipe
- Replacement washers available
- Compact
- No solvent welding required

Type	Code
Universal Telescopic Trap with Adaptors (76mm seal)	368240



Straight through Pedestal Trap

MOSTLY USED WITH DOMESTIC AND PROFESSIONAL BASINS

- Quick and easy to fit
- Manufactured to BS EN274
- Telescopic
- Supplied with unifix outlet to suit polypropylene, ABS and copper pipe
- Replacement washers available
- No solvent welding required

Size	Code
32mm x 75mm Seal	368225



Bottle Traps with Standard (Fixed) Inlets - Anti-Vac

MOSTLY USED WITH DOMESTIC AND PROFESSIONAL BASINS

- Quick and easy to fit
- Manufactured to BS EN274
- Fixed Inlet
- Supplied with unifix outlet to suit polypropylene, ABS and copper pipe
- Replacement washers available
- No solvent welding required
- Range of seal sizes

Size	Code
32mm x 38mm Seal	368244
38mm x 38mm Seal	368246
32mm x 75mm Seal	368242
38mm x 75mm Seal	368243

Bathroom/Kitchen Accessories // Wastes, Traps and Accessories 01



Appliance Traps

MOSTLY USED WITH DOMESTIC AND PROFESSIONAL APPLIANCES

- Quick and easy to fit
- Manufactured to BS EN274
- Supplied with unifix outlet to suit polypropylene, ABS and copper pipe
- Replacement washers available
- No solvent welding required
- Available in a range of sizes and styles

Size	Code
38mm x 75mm Seal - Single Inlet	368230
38mm x 75mm Seal - Double Inlet	368231
38mm x 75mm Seal - Inlet Tee	368232
38mm x 75mm Seal (600mm Stand Pipe)	368228



Low Level Bath P Trap

TO SUIT BOTH TRADITIONAL AND CONTEMPORARY BATHROOM DESIGNS

- Quick and easy to fit
- Ideal for bath installations where space is limited
- 1.½" / 42mm connection compatible with standard bath waste systems
- 2 integrated cleaning eyes allow access for clearing blockages and routine maintenance
- Optional L-shaped extension tube with flange for installations requiring additional reach or alignment flexibility

Size	Code
Low Level Bath P Trap with 2 Cleaning Eyes	368296
Low Level Bath P Trap with 2 Cleaning Eyes C/W L Shaped ext tube with flange	335177



Shower Trap

MOSTLY USED WITH DOMESTIC AND PROFESSIONAL APPLIANCES

- 90 x 50mm Seal
- Designed for UK standard shower trays and offers efficient, high-speed drainage
- 1.½" outlet
- Easy to clean design ensures long-lasting performance and hygiene

Size	Code
Chrome Shower Trap	368299
Matt Black Shower Trap	335177



Example Nickel Finish

Chrome Plated Bottle Trap

TRADITIONAL STYLED BOTTLE TRAP

- Quick and easy to fit
- Adjustable
- Chrome finish - other finishes available
- Comes with 35mm stainless steel extension and wallplate
- Other thread sizes, outlets and extension tube sizes available
- Replacement washers available

Size	Code
1.½"	368254



Example Matt Black Finish

Chrome Plated Bottle Trap

MODERN STYLED BOTTLE TRAP

- Quick and easy to fit
- Adjustable
- Comes with 35mm stainless steel extension and wallplate
- Replacement washers available

Size	Code
1.½"	368255



Example Matt Black Finish

Chrome Plated Bottle Trap

SQUARE STYLED BOTTLE TRAP

- Quick and easy to fit
- Adjustable
- Comes with 35mm stainless steel extension and wallplate
- Replacement washers available

Size	Code
1.½"	335164

Explore our full range in our Epson Wastes and Accessories brochure - We can supply any waste in any finish.

01 Bathroom/Kitchen Accessories // Pan Connectors

RIGIFLEX PAN CONNECTOR

BATHROOM ACCESSORIES // PAN CONNECTORS

Rigiflex Flexible WC Pan Connector

- Adjustable 230mm - 570mm (extendable)



Size	Code
230 - 570mm Extendable	313672

EXTENDABLE PAN CONNECTOR

BATHROOM ACCESSORIES // PAN CONNECTORS

Extendable Flexible Pan Connector

- x3 Extendable sizes
- 80 - 105mm Inlet
- 100 - 110mm Outlet
- Made to BS5627
- 10 Year Warranty



Size	Code
310mm - 650mm Length	363739
270mm - 500mm Length	363740
250mm - 350mm Length	363741

90° S EXTENDABLE PAN CONNECTOR

BATHROOM ACCESSORIES // PAN CONNECTORS

90° S Extendable Pan Connector. 280-460mm

- 90° S Pan Connector
- Extendable 280mm - 460mm
- 89 - 107mm Inlet
- 100 - 110mm Outlet
- Pack Qty: 24
- Made to BS5627
- 10 Year Warranty



Size	Code
280mm - 460mm	363742

Bathroom/Kitchen Accessories // Pan Connectors 01

90° S EXTENDABLE PAN CONNECTOR

BATHROOM ACCESSORIES // PAN CONNECTORS

90° S Extendable Pan Connector - 340-700mm

- 89 - 107mm Inlet / 100 - 110mm Outlet
- Pack Qty: 20
- Made to BS5627
- 10 Year Warranty



Item	Code
340mm - 700mm	363743

90° S EXTENDABLE PAN CONNECTOR WITH OUTLET

BATHROOM ACCESSORIES // PAN CONNECTORS

90° S Extendable Pan Connector with Outlet 240-460mm

- 90° S Extendable Pan Connector w/Outlet
- Extendable 240mm - 460mm
- 89 - 107mm Inlet
- 100 - 110mm Outlet
- Pack Qty: 24
- Made to BS5627
- 10 Year Warranty



Size	Code
240mm - 460mm	363744

90° S EXTENDABLE PAN CONNECTOR WITH OUTLET

BATHROOM ACCESSORIES // PAN CONNECTORS

S Extendable Pan Connector with Outlet 340-700mm

- S Extendable Pan Connector w/Outlet
- Extendable 340mm - 700mm
- 89 - 107mm Inlet
- 100 - 110mm Outlet
- Pack Qty: 20
- Made to BS5627
- 10 Year Warranty



Size	Code
340mm - 700mm	363745

01 Bathroom/Kitchen Accessories // Pan Connectors



STRAIGHT PAN CONNECTOR

BATHROOM ACCESSORIES // PAN CONNECTORS

Rigid Pan Connector – Straight

- Straight
- 90mm Length
- 89 - 107mm Inlet
- 90 - 100 - 110mm Outlet
- Pack Qty: 40
- Made to BS5627
- 10 Year Warranty

Size	Code
90mm Length Rigid Pan Connector	363732



EXTENDED STRAIGHT PAN CONNECTOR

BATHROOM ACCESSORIES // PAN CONNECTORS

Rigid Pan Connector – Extended Straight - 250mm

- 89-107mm Inlet / 100mm Outlet
- Pack Qty: 16
- Made to BS5627
- 10 Year Warranty

Item	Code
250mm	363736



ECCENTRIC OFFSET 20mm PAN CONNECTOR

BATHROOM ACCESSORIES // PAN CONNECTORS

Rigid Pan Connector – Eccentric/offset 20mm

- Eccentric/offset 20mm
- 127mm Length
- 89 - 107mm Inlet
- 90 - 100 - 110mm Outlet
- Pack Qty: 40
- Made to BS5627
- 10 Year Warranty

Size	Code
127mm Length Eccentric/offset 20mm	363733

Bathroom/Kitchen Accessories // Pan Connectors 01



ECCENTRIC OFFSET 40mm PAN CONNECTOR

BATHROOM ACCESSORIES // PAN CONNECTORS

Rigid Pan Connector – Eccentric/offset 40mm

- Eccentric/offset 40mm
- 122mm Length
- 89 - 107mm Inlet
- 90 - 100 - 110mm Outlet
- Pack Qty: 20
- Made to BS5627
- 10 Year Warranty

Size	Code
Eccentric/offset 40mm - 122mm Length	363734



ECCENTRIC OFFSET 60mm PAN CONNECTOR

BATHROOM ACCESSORIES // PAN CONNECTORS

Rigid Pan Connector – Eccentric/offset 60mm

- Eccentric/offset 60mm
- 122mm Length
- 89 - 107mm Inlet
- 90 - 100 - 110mm Outlet
- Pack Qty: 20
- Made to BS5627
- 10 Year Warranty

Size	Code
Eccentric/offset 60mm - 122mm Length	363735



90° ADJUSTABLE PAN CONNECTOR 300mm

BATHROOM ACCESSORIES // PAN CONNECTORS

Rigid Pan Connector – 90° S Adjustable 300mm

- Adjustable by cutting 300mm
- 360mm Length
- 89 - 107mm Inlet
- 100 - 110mm Outlet
- Pack Qty 16
- Made to BS5627
- 10 Year Warranty

Size	Code
90° Adjustable - 360mm Length	363738

01 Bathroom/Kitchen Accessories // Pan Connectors



90° ADJUSTABLE PAN CONNECTOR 350mm

BATHROOM ACCESSORIES // PAN CONNECTORS

Rigid Pan Connector – 90° S Adjustable 350mm

- Adjustable by cutting 350mm
- 360mm Length
- 89 - 107mm Outlet
- 90 - 100 - 110mm Inlet
- Pack Qty 20
- Made to BS5627
- 10 Year Warranty

Item	Code
90° Adjustable Pan Connector - 350mm	363738



104° PAN CONNECTOR

BATHROOM ACCESSORIES // PAN CONNECTORS

Rigid Pan Connector – 104°

- 150mm Length
- 89 - 110mm Inlet
- 90 - 100 - 110mm Outlet
- Made to BS5627
- 10 Year Warranty

Item	Code
Rigid Pan Connector – 104°	363724



BACK TO WALL PAN CONNECTOR 90° ADJUSTABLE 350mm

BATHROOM ACCESSORIES // PAN CONNECTORS

Back to the Wall Pan Connector - 90° Adjustable by cutting 350mm

- 360mm Length
- 89 - 100mm Inlet
- 80 - 110mm Outlet
- Supplied with stabilising bolt which is designed to make back to wall installation easy and secure
- Made to BS5627
- 10 Year Warranty

Size	Code
360mm Length	363746

Bathroom/Kitchen Accessories // Pan Connectors 01



BACK TO WALL PAN CONNECTOR 90° ADJUSTABLE 0-15cm

BATHROOM ACCESSORIES // PAN CONNECTORS

90° Adjustable by cutting 0 – 15cm reach

- 343mm Length
- 95 - 105mm Inlet
- 100 - 110mm Outlet
- Supplied with stabilising bolt which is designed to make back to wall installation easy and secure
- Made to BS5627
- 10 Year Warranty

Size	Code
Back to wall Pan Connector 90° Adjustable - 343mm Length	363747



S BACK TO WALL PAN CONNECTOR

BATHROOM ACCESSORIES // PAN CONNECTORS

Back to the Wall S Pan Connector Adjustable by cutting 15 – 20cm reach

- 343mm Length
- 87-105mm Inlet
- 100 - 110mm Outlet
- Supplied with stabilising bolt which is designed to make back to wall installation easy and secure
- Made to BS5627
- 10 Year Warranty

Size	Code
Back to Wall S Pan Connector - 343mm Length	363748



01 Bathroom/Kitchen Accessories // Toilet Seats



DANIELLE

BATHROOM ACCESSORIES // PLUMBING FITTING & SPARES

Thermoplastic medium-duty toilet seat with adjustable plastic hinges

- Adjustable plastic hinges
- Medium Duty 1.65kg Seat
- 456mm x 378mm
- 2 year guarantee

Item	Code
Danielle	320732



FRANCESCA

BATHROOM ACCESSORIES // PLUMBING FITTING & SPARES

Thermoset, heavy-duty toilet seat with adjustable hinges

- Adjustable stainless steel hinges
- Heavy Duty 2.5kg Seat
- 440mm x 370mm
- 2 year guarantee

Item	Code
Francesca	320727



NADIA

BATHROOM ACCESSORIES // PLUMBING FITTING & SPARES

Thermoset, heavy-duty wrap-over style toilet seat

- Adjustable stainless steel hinges
- Heavy Duty 2.2kg Seat
- Wrap-over style cover
- 446mm x 370mm
- 2 year guarantee

Item	Code
Nadia	320729

Bathroom/Kitchen Accessories // Accessories 01

Can be Supplied in Pre-Pack



Toilet Seat Hinges

CHROME PLATED PILLAR HINGES

- Chrome Plated
- Bar Hinge
- C/W Universal Seat Fixing Kit

Item	Code
Toilet Seat Pillar Hinges	367422



Toilet Seat Hinges

CHROME PLATED 'L' SHAPED HINGES

- Chrome Plated
- 'L' Shaped

Item	Code
Toilet Seat Hinges	367418



Toilet Seat Hinges

CHROME PLATED BAR HINGES

- Chrome Plated

Item	Code
Toilet Seat Bar Hinges	367416



Toilet Seat Hinges

UNIVERSAL SEAT FIXING KIT

- Pillar hinges
- Universal Seat Fixing Kit supplied with:
 - 8cm [3"] all-thread
 - Screws
 - Washers
 - Wing Nuts

Item	Code
Toilet Seat Hinges - Universal Seat Fixing Kit	367424



Toilet Seat Hinges

WHITE PLASTIC TOILET SEAT HINGES

- White Plastic Hinges
- Rod
- Double Piston

Item	Code
Toilet Seat Hinges	367425



Toilet Seat Hinges

BLACK PLASTIC TOILET SEAT HINGES

- Black Plastic Hinges
- Rod
- Double Piston

Item	Code
Toilet Seat Hinges	367426

01 Bathroom/Kitchen Accessories // Accessories



Toilet Roll Holder
CHROME MEDIUM PATTERN
TOILET ROLL HOLDER

- Chrome

Item	Code
Toilet Roll Holder	366565



Toilet Roll Holder
STAINLESS STEEL TOILET ROLL HOLDER

- Stainless Steel
- Suitable for domestic and commercial use

Item	Code
Toilet Roll Holder	366566



Toilet Roll Holder
LOCKING CHROME TOILET ROLL HOLDER

- Pack Qty: 1
- Chrome
- Lockable – supplied with key

Item	Code
Toilet Roll Holder	366563



Toilet Roll Holder
SPARE TOILET ROLL HOLDER ROLLER

- Pack Qty: 10
- Plastic

Item	Code
Toilet Roll Holder White	367428
Toilet Roll Holder Black	367429



Tap Swops
REPLACEMENT TAP HANDLES (PAIR)

- Adjustable to fit most spindles
- No plumbing required
- Supplied complete with fixings
- Sold as a pair

Item	Code
Tap Swops	366509



Tap Swops
METAL REPLACEMENT TAP HANDLES (PAIR)

- Adjustable to fit most spindles
- No plumbing required
- Supplied complete with fixings
- Sold as a pair

Item	Code
Tap Swops	366511

Bathroom/Kitchen Accessories // Accessories 01



Tap Swops
REPLACEMENT CROSS
HEAD TAP HANDLES (PAIR)

- Adjustable to fit most spindles
- No plumbing required
- Supplied complete with fixings
- Sold as a pair

Item	Code
Tap Swops	366512



Shower Hose
REPLACEMENT FOR ANY SHOWER

- Easy to install
- Standard ½" BSPT
- Manufactured from stainless steel – won't rust
- Replacement washers available

Size	Code
1.25m	364280
1.5m	364281
2m	364282



Shower Curtain
WHITE SHOWER CURTAIN

- 100% Polyester
- Lead Weighted Hem
- Brass Eyelets

Size	Code
2100mm x 2100mm	366581
1800mm x 1800mm	366582



Quarter Turn Tap Glands

Single without threaded collar



Tap Top Headwork Gland

Pair with threaded collar



Quarter Turn Tap Glands & Tap Top Headwork Gland

QUARTER TURN CERAMIC TAP GLANDS, 20 SPLINE

- High Spline
- Sold in Pairs

TAP TOP HEADWORK GLAND, 20 SPLINE – 7.5mm X 8.5mm.

- 7.5mm x 8.5mm

QUARTER TURN CERAMIC TAP GLANDS

Size	Code
8mm x 12mm	367895
7.6mm x 14.9mm	367896
7.7mm x 14.5mm	367897

TAP TOP HEADWORK GLANDS

Size	Code
7.5mm x 8.5mm – With threaded collar (sold in pairs)	367898
7.5mm x 8.5mm – Without threaded collar (sold in singles)	376740

Can be Supplied
in Pre-Pack



01 Bathroom/Kitchen Accessories // Accessories



Sanitary Fixing Kit
VERTICAL WC PAN FIXING KIT

- White and Chrome Caps
- No.6 x 70mm Screws

Item	Code
Sanitary Fixing Kit	367413



Sanitary Fixing Kit
HORIZONTAL PAN & BIDET FIXING KIT

- No.6 x 70mm Hex Screws
- No.5 x 50mm SS Screws

Item	Code
Sanitary Fixing Kit	367405



Sanitary Fixing Kit
WASHBASIN AND BIDET WALL FIXING KIT

- Suitable for Washbasin and Bidet

Size	Code
M10 x 120mm	367407
M10 x 140mm	367408
M8 x 110mm	367410



Cistern Support Brackets
CISTERN SUPPORT BRACKETS

- 102mm x 102mm (4" x 4")
- Supplied in Pairs

Item	Code
Cistern Support Brackets (4" x 4")	366476



Cistern Support Brackets
CISTERN SUPPORT BRACKETS

- 102mm x 51mm (4" x 2")
- Supplied in Pairs

Item	Code
Cistern Support Brackets (4" x 2")	367395



Basin Hanger Bracket
BASIN HANGER BRACKET - PRESSED STEEL

- Made from Pressed Steel
- Supplied in Pairs

Item	Code
Basin Hanger Bracket	367396



Basin/Urinal Bracket
HEAVY DUTY BASIN/URINAL BRACKET

- Suitable for Basin and Urinal
- Supplied in Pairs

Item	Code
Basin/Urinal Bracket	367398



Urinal Brackets
NARROW URINAL BRACKETS (PAIR)

- Narrow Urinal Brackets
- Supplied in Pairs

Item	Code
Urinal Brackets	367401



Basin Bracket
SEMI RECESSED BASIN BRACKET

- Semi Recessed Bracket with Screws

Item	Code
Basin Bracket	367403

Bathroom/Kitchen Accessories // Grab Rails 01



Bath Grips
CHROME PLATED BATH GRIPS

- Supplied in Pairs

Size	Code
190mm Standard, Top Fixing	364861
190mm Standard, Bottom Fixing	364860
254mm Eu Standard, Top Fixing	364863
255mm Eu Standard, Top Fixing, Profile	364859
254mm Eu Standard, Top Fixing, Profile	364864



Support Rail
HINGED SUPPORT RAIL

- 32mm Dia. X 750mm Length

Item	Code
Hinged Support Rail	364279



Grab/Support Rails
STEEL GRAB SUPPORT RAILS - CHROME PLATED OR WHITE

- Steel Grab Support Rails
- Available in Chrome or White

Size	Code
25mm Dia, 228mm Length Chrome Plated	364259
25mm Dia, 228mm Length White Coated	364258
25mm Dia, 305mm Length Chrome Plated	364261
25mm Dia, 305mm Length White Coated	364260
35mm Dia, 305mm Length Chrome Plated	364271
35mm Dia, 305mm Length White Coated	364270
25mm Dia, 457mm Length Chrome Plated	364264

Size	Code
25mm Dia, 457mm Length White Coated	364263
35mm Dia, 457mm Length Chrome Plated	364273
35mm Dia, 457mm Length White Coated	364272
25mm Dia, 610mm Length Chrome Plated	364267
25mm Dia, 610mm Length White Coated	364266
35mm Dia, 610mm Length Chrome Plated	364275



Grab Rail
ABS GRAB/SUPPORT RAIL (PLASTIC)

- Supplied with fixing screws
- Larger than normal diameter makes them easier to grasp
- Ribbed to ensure they are easier to grip
- Manufactured from high quality materials

Diameter	Length	Code
35mm	305mm	364276
35mm	457mm	364277
35mm	610mm	364278



Grab Rail
STAINLESS STEEL GRAB RAIL

- 32mm Diameter
- 305mm Length
- Supplied with fixing screws
- Larger than normal diameter makes them easier to grasp
- Manufactured from high quality stainless steel - won't rust

Item	Code
Stainless Steel Grab Rail	364269

Can be Supplied in Pre-Pack

01 Bathroom/Kitchen Accessories // Plugs and Chains



White Tap Hole Stopper

- WHITE TAP HOLE STOPPER WITH LOCKING NUT
- An effective way of covering up any unwanted holes left by taps

Item	Code
White Tap Hole Stopper	367180



Chrome Tap Hole Stopper

- CHROME PLATED TAP HOLE STOPPER WITH LOCKING NUT
- An effective way of covering up any unwanted holes left by taps

Item	Code
Chrome Tap Hole Stopper	367183



Bath Overflow Stopper

- BATH OVERFLOW STOPPER
- Includes Locknut and Triangle
 - Easy to fit

Finish	Code
White Bath Overflow Stopper	367190



Bath Overflow Stopper

- BATH OVERFLOW STOPPER
- Includes Locknut and Triangle
 - Chrome plated ABS
 - Easy to fit

Finish	Code
Chrome Bath Overflow Stopper	367191



Cistern Hole Stopper

- CISTERN HOLE STOPPER. WHITE
- Supplied With Locknut
 - 1/2" BSP thread
 - Easy to fit
 - Available in white & chrome plated finishes

Finish	Code
White	367194



Cistern Hole Stopper

- CISTERN HOLE STOPPER. CHROME PLATED
- Supplied With Locknut
 - BSP thread
 - Easy to fit
 - Available in white & chrome plated finishes

Finish	Code
Chrome Plated	367199



Sink Overflow Stopper

- WITH BLACK PLUG AND BACKNUT
- 32mm Black Sink Overflow Stopper
 - Comes with Cap, Nut and Triangle

Item	Code
Sink Overflow Stopper	367189



Overflow Stopper

- WHITE OVERFLOW STOPPER
- White Overflow Stopper supplied with 19mm [3/4"] Washer and Jamnut for a secure fit.

Item	Code
Overflow Stopper	367198

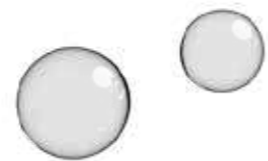

Can be Supplied in Pre-Pack

Bathroom/Kitchen Accessories // Plugs and Chains 01



Pop Up Plug

- POP UP PLUG CHROME
- Chrome Effect
 - Pup Up Plug

Finish	Code
Chrome Effect	368155
Gold Effect	368156



1.1/2" Plug

- 38mm POLYTHENE PLUG
- Supplied with triangle

Colour	Code
White	367166



1.3/4" Plug

- 42mm POLYTHENE PLUG
- Supplied with triangle

Colour	Code
White	367171



1.1/2" Plug

- 38mm POLYTHENE PLUG
- Supplied with triangle

Colour	Code
Black	367167



1.3/4" Plug

- 42mm POLYTHENE PLUG
- Supplied with triangle

Colour	Code
Black	367172



Chrome Plug

- CHROME PLATED ON BRASS PLUG
- Chrome plated on brass plug
 - Supplied with triangle

Size	Code
38mm (1.1/2")	367170



Chrome Plug

- CHROME PLATED ON BRASS PLUG
- Chrome plated on brass plug
 - Supplied with triangle

Size	Code
42mm (1.3/4")	367175

White Plug

RUBBER PLUG. VARIOUS SIZES

- Our range of Rubber Plugs are manufactured from high quality rubber to provide a long life method of sealing water into your sink, bath or basin. Available in a wide range of sizes. Supplied with triangle

Size	Code
25mm (1")	367228
32mm (1.1/4")	367230
38mm (1.1/2")	367233
41mm (1.3/8")	367235



Size	Code
44mm (1.3/4")	367237
51mm (2")	367241
54mm (2.1/4")	367243
64mm (2.1/2")	367247

Can be Supplied in Pre-Pack

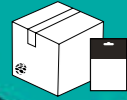

01 Bathroom/Kitchen Accessories // Plugs and Chains



Any Waste. Any Finish.

Basin | Bath Ball Chain

BASIN | BATH BALL CHAIN AND FITTINGS

- Basin - 305mm (12")
- Bath 457mm (18") available
- Available in a range of styles
- Stylish and simple ball chain



Fittings	Code
305mm [12"] Ball Chain Stay and Hook	367202
305mm [12"] Ball Chain Hook Both Ends	367204
305mm [12"] Ball Chain Hook and Black 38mm [1.½"] Poly Plug	367206
457mm [18"] Ball Chain Stay and Hook	367215
457mm [18"] Ball Chain Hook Both Ends	367217
457mm [18"] Ball Chain Hook and Black 42mm [1.¾"] Poly Plug	367219

Basin | Bath Oval Link Chain

BASIN OVAL LINK CHAIN AND FITTINGS

- Basin - 305mm (12")
- Bath 457mm (18") available
- Available in a range of styles
- Stylish and simple oval link chain



Fittings	Code
305mm [12"] Oval chain Stay and Hook	367209
305mm [12"] Oval Chain Hook Both Ends	367211
305mm [12"] Oval Chain Hook and Black 38mm [1.½"] Poly Plug	367213
457mm [18"] Oval Chain Stay and Hook	367221
457mm [18"] Ball Chain Hook Both Ends	367223
457mm [18"] Ball Chain Hook and Black 42mm [1.¾"] Poly Plug	367225

Basin Ball Chain

BASIN BALL CHAIN AND FITTINGS

- Basin - 305mm (12")
- White Rubber
- Available in a range of styles
- Stylish and simple ball chain



Fittings	Code
305mm [12"] Basin Ball Chain Stay & Hook and 38mm [1.½"] White Rubber Plug	367248
305mm [12"] Basin Ball Chain Stay & Hook and 42mm [1.¾"] White Rubber Plug	367249

Basin Ball Chain

BASIN BALL CHAIN AND FITTINGS

- Basin - 305mm (12")
- Chrome Brass Plug
- Available in a range of styles
- Stylish and simple ball chain



Fittings	Code
305mm [12"] Basin Ball Chain Stay & Hook and 38mm [1.½"] Chrome Brass Plug	335185

Cistern Levers and Pulls 02

Can be Supplied in Pre-Pack



WEDGE WASHER LEVER

BATHROOM ACCESSORIES // CISTERN LEVERS AND PULLS

Cistern Lever with Wedge Washer

- 120mm Spindle
- ½" Bush – Suitable for most standard cisterns
- Supplied with plastic multi purpose lift arm
- Suitable for curved fronted cisterns



Item	Code
120mm Spindle Chrome Effect	367100

E TYPE CISTERN LEVER

BATHROOM ACCESSORIES // CISTERN LEVERS AND PULLS

E-Type Finger Tip Front Cistern Levers

- ½" Bush – Suitable for most standard cisterns
- Supplied with plastic multi purpose lift arm



Item	Code
88mm Spindle Chrome Effect	367088
110mm Spindle Chrome Effect	367085
88mm Spindle Gold Effect	367132

D TYPE CISTERN LEVER

BATHROOM ACCESSORIES // CISTERN LEVERS AND PULLS

D-Type Cistern Grab Lever – Plastic Lift Arm

- 110mm Spindle
- ½" Bush – Suitable for most standard cisterns
- Supplied with plastic multi purpose lift arm



Item	Code
110mm Spindle	367078

Can be Supplied in Pre-Pack

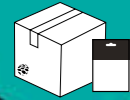

02 Cistern Levers and Pulls

D TYPE CISTERN LEVER

BATHROOM ACCESSORIES // CISTERN LEVERS AND PULLS

D-Type Plastic Cistern Grab Lever – Brass Lift Arm

- 110mm Spindle
- ½" Bush - Supplied with Brass Adjustable Lift Arm



Item	Code
110mm Spindle Chrome Effect	367072
110mm Spindle Gold Effect	367129

S TYPE CISTERN LEVER

BATHROOM ACCESSORIES // CISTERN LEVERS AND PULLS

S-Type ¾" Front Cistern Levers

- 110mm Spindle
- ¾" Bush – Suitable for Ideal Standard cisterns with a smaller hole
- Supplied with plastic multi purpose lift arm



Item	Code
110mm Spindle Chrome Effect	367090
110mm Spindle Gold Effect	367133

X TYPE CISTERN LEVER

BATHROOM ACCESSORIES // CISTERN LEVERS AND PULLS

X-Type ¾" & ½" Universal Front Cistern Lever

- 110mm Spindle
- ¾" Bush - Suitable for Ideal Standard cisterns with a smaller hole
- ½" Bush - Suitable for most standard cisterns
- Supplied with plastic multi purpose lift arm



Finish	Code
110mm Spindle Chrome Effect	367093
110mm Spindle Gold Effect	367134

Can be Supplied in Pre-Pack



Cistern Levers and Pulls 02

E TYPE SIDE CISTERN LEVER

BATHROOM ACCESSORIES // CISTERN LEVERS AND PULLS

E Type Chrome Plated Cistern Side Lever

- 160mm Spindle
- ½" Bush – Suitable for most standard cisterns
- Plastic Lift Arm – Supplied with plastic multi purpose lift arm



Item	Code
160mm Spindle Cistern Lever	367087

ENABLER CISTERN LEVER

BATHROOM ACCESSORIES // CISTERN LEVERS AND PULLS

Chrome Plated Enabler Cistern Lever

- 120mm Spindle
- ½" Bush – Suitable for most standard cisterns
- Supplied with plastic multi purpose lift arm



Item	Code
120mm Spindle Chrome Effect	367095

DIMPLE CISTERN LEVER

BATHROOM ACCESSORIES // CISTERN LEVERS AND PULLS

Chrome Plated Cistern Dimple Lever

- 114 / 225 / 325 / 430mm Spindle
- ½" Bush – Suitable for most standard cisterns
- Camel Multi Purpose Lift Arm
- Replaces most lever for easy operation



Item	Code
120mm Spindle Chrome Effect	315568
225mm Spindle Chrome Effect	317591
325mm Spindle Chrome Effect	318252
430mm Spindle Chrome Effect	318138



02 Cistern Levers and Pulls



PADDLE CISTERN LEVER

BATHROOM ACCESSORIES // CISTERN LEVERS AND PULLS

Chrome Plated Cistern Paddle Lever

- 100mm Spindle

Item	Code
110mm Spindle Chrome Plated	367098



D TYPE CONCEALED CISTERN LEVER

BATHROOM ACCESSORIES // CISTERN LEVERS AND PULLS

D Type Concealed Cistern Lever

- Range of spindle sizes
- 3/8" Bush – Suitable for Ideal Standard cisterns with a smaller hole
- Brass Adjustable Lift Arm

Item	Code
160mm (6") Spindle Chrome Effect	367073
225mm (9") Spindle Chrome Effect	367075
305mm (12") Spindle Chrome Effect	334610
160mm (6") Spindle Gold Effect	367125
225mm (9") Spindle Gold Effect	367126
305mm (12") Spindle Gold Effect	367127



D TYPE CONCEALED CISTERN LEVER

BATHROOM ACCESSORIES // CISTERN LEVERS AND PULLS

D Type Special Length Concealed Cistern Levers

- Range of spindle sizes
- Chrome Plated
- 3/8" Bush – Suitable for Ideal Standard cisterns with a smaller hole
- Plastic Lift Arm – Supplied with plastic multi purpose lift arm

Item	Code
357mm (14") Spindle Chrome Effect	367081
408mm (16") Spindle Chrome Effect	367082
460mm (18") Spindle Chrome Effect	367083
600mm (24") Spindle Chrome Effect	367084



Cistern Levers and Pulls 02



CLASSIC CISTERN LEVER MAHOGANY

BATHROOM ACCESSORIES // CISTERN LEVERS AND PULLS

Mahogany Finish Wooden Front Cistern Lever

- 110mm Spindle
- 1/2" Bush - Suitable for most standard cisterns
- Supplied with plastic multi purpose lift arm

Item	Code
110mm Spindle Chrome and Mahogany	367110
110mm Spindle Gold Effect and Mahogany	367142



CLASSIC CISTERN LEVER - PINE

BATHROOM ACCESSORIES // CISTERN LEVERS AND PULLS

Pine Finish Wooden Front Cistern Lever

- 110mm Spindle
- 1/2" Bush - Suitable for most standard cisterns
- Supplied with plastic multi purpose lift arm

Item	Code
110mm Spindle Chrome and Pine	367111
110mm Spindle Gold Effect and Pine	367143
110mm Spindle Gold Effect and Pine	367146



CLASSIC CISTERN LEVER - LIGHT OAK

BATHROOM ACCESSORIES // CISTERN LEVERS AND PULLS

Classic Wooden Front Cistern Lever – Light Oak Finish

- 110mm Spindle
- 1/2" Bush - Suitable for most standard cisterns
- Supplied with plastic multi purpose lift arm
- Chrome and Light Oak

Item	Code
110mm Spindle Chrome & Light Oak	367109



02 Cistern Levers and Pulls

CERAMIC CISTERN LEVER

BATHROOM ACCESSORIES // CISTERN LEVERS AND PULLS

Deluxe Ceramic Front Levers

- ½" Bush – Suitable for most standard cisterns
- ¾" Bush – Suitable for Ideal Standard cisterns with a smaller hole
- Supplied with plastic multi purpose lift arm



Item	Code
110mm Spindle White - ½" Bush	367113
110mm Effect Gold Spindle - ½" Bush	367144
110mm Spindle White - ¾" Bush	367116
110mm Spindle Gold Effect - ¾" Bush	367147

CONCEALED CLASSIC CISTERN LEVER

BATHROOM ACCESSORIES // CISTERN LEVERS AND PULLS

Concealed Classic Cistern Levers

- ¾" Bush – Suitable for Ideal Standard cisterns with a smaller hole
- Supplied with plastic and brass adjustable multi purpose lift arm



Item	Lift Arm	Code
160mm Spindle Chrome and White	Plastic	367102
160mm Spindle Gold Effect	Plastic	367137
225mm Spindle Chrome and White	Brass	367103
225mm Spindle Gold Effect	Brass	367139

CERAMIC CISTERN LEVER

BATHROOM ACCESSORIES // CISTERN LEVERS AND PULLS

Classic Ceramic Side Cistern Lever

- 160mm Spindle
- ½" Bush – Suitable for most standard cisterns
- Supplied with plastic multi purpose lift arm



Item	Code
160mm Spindle Chrome and White	367101
160mm Spindle Gold Effect	367137

Cistern Levers and Pulls 02



CERAMIC CISTERN LEVER

BATHROOM ACCESSORIES // CISTERN LEVERS AND PULLS

Economy Ceramic Front Cistern Lever

- 110mm Spindle
- ½" Bush – Suitable for most standard cisterns
- Supplied with plastic multi purpose lift arm
- White



Item	Code
110mm Spindle	367108



02 Cistern Levers and Pulls



CISTERN PULL

BATHROOM ACCESSORIES // CISTERN LEVERS AND PULLS

Victoriana Ceramic Cistern Pull Handle

- Supplied with a chrome plated 30" chain
- "Pull" Motif

Item	Code
Cistern Pull	367119



CISTERN PULL

BATHROOM ACCESSORIES // CISTERN LEVERS AND PULLS

Rubber Cistern Pull Handle

- Supplied with a chrome plated 30" chain

Item	Code
Cistern Pull	367310



CISTERN PULL

BATHROOM ACCESSORIES // CISTERN LEVERS AND PULLS

Wooden Cistern Pull Handle

- Supplied with a chrome plated 30" chain

Item	Code
Cistern Pull	367313

Cistern Levers and Pulls 02

Can be Supplied in Pre-Pack



High Level Cistern Lever

DIPLOMAT HIGH LEVEL CISTERN LEVER

- Supplied with fulcrum bracket and screw

Item	Code
High Level Cistern Lever	320008



High Level Cistern Lever

TRI-SHELL HIGH LEVEL CISTERN LEVER

- Supplied with fulcrum bracket and screw

Item	Code
High Level Cistern Lever	316173



High Level Cistern Lever

CHROME PLATED HIGH LEVEL CISTERN LEVER

- Supplied with fulcrum bracket and screw
- Chrome Plated

Item	Code
High Level Cistern Lever	367163



High Level Cistern Lever

POLISHED BRASS HIGH LEVEL CISTERN LEVER

- Supplied with fulcrum bracket and screw
- Polished Brass

Item	Code
High Level Cistern Lever	330217



Lift Arm

NATURAL PLASTIC MULTI PURPOSE ADJUSTABLE LIFT-ARM

Item	Code
Lift Arm	367162



Lift Arm

BRASS ADJUSTABLE LIFT-ARM

Item	Code
Lift Arm	367159



Lift Arm

BLUE 'CAMEL' ADJUSTABLE LIFT-ARM

Item	Code
Lift Arm	316340



Lift Arm

NATURAL 'CAMEL' ADJUSTABLE LIFT-ARM

Item	Code
Lift Arm	317165



Lift Arm Bush

NATURAL 13mm (1/2") CISTERN LEVER BUSH

Item	Code
Lift Arm Bush	367158

Can be Supplied in Pre-Pack

03 Cistern & Tank Fittings // Syphon & Flush Valve Accessories



Coupling Nuts

HIGH QUALITY THREADED COUPLING NUT

- Manufactured from high quality materials and internally threaded
- Wide range of sizes providing plenty of options for all types of installations

Size	Code
19mm [¾"]	372927
25mm [1"] 22mm I.D.	370785
25mm [1"] 28mm I.D.	368270
32mm [1.¼"] to suit 1" Pipe	368273
32mm [1.¼"] to suit 1.¼" Pipe	368274
50mm [2"]	371038
50mm [2"] European Thread	368275



Jamb Nuts

HIGH QUALITY THREADED JAMB NUT

- Manufactured from high quality materials
- Range of sizes from 10mm (¾") to 50mm (2")
- Internal thread
- European thread also available

Size	Code
10mm [¾"]	370343
13mm [½"]	370223
19mm [¾"]	370222
25mm [1"]	370815
32mm [1.¼"]	368277
38mm [1.½"]	370216
50mm [2"]	368278



C-Links

STAINLESS STEEL 'C' LINKS

- Manufactured from high-quality stainless steel
- Connects syphon to cistern lever; easy flushing

Size	Code
2"	364880
Up to 3"	318134
3"	364882
3.½"	317307
3.¾"	317898
Up to 4"	317143
4"	364884
4.¼"	322946
4.½"	318323
5.½"	317537



Syphon Diaphragm Washer

ROUND / OVAL SYPHON DIAPHRAGM WASHER

- 114mm [4.½"] and 127mm [5"] Round Shape in clear, strong plastic
- 138mm [5"] Oval Shape in clear, strong plastic
- Seals syphon housing to ensure water efficient flush

Item	Code
4.½" Round	367473
5" Round	367477
5" Oval	313245



Petcock

ADJUSTABLE FLOW CONTROL PETCOCK. FOR USE WITH AUTOMATIC SYPHONS

- Suitable for use with Automatic Syphons see page 47
- Fitted to inlet pipe for adjustable flow control
- Can be easily adjusted by removing end cap, & twisting the valve inside to control fill rate to desired flow

Item	Code
Petcock (½" BSPT)	364979



Sparg Pipe Sets

STAINLESS STEEL SPARGE SETS

- Includes Brackets & Fixings
- 23mm Bowl Offset & 90mm Cistern Offset
- Multiple Bowl set options

Bowl Set	Code
1	330621
2	330622
3	330623
4	330624



Urinal Spreader

TOP INLET

- Top inlet is a push-fit mechanism; easy install
- Mostly used as a replacement in exposed urinal cistern systems

Inlet	Code
Top Inlet Urinal Spreader	364969



Urinal Spreader

BACK INLET

- Mostly used as a replacement in concealed urinal cistern systems
- Back Inlet Tail is made from solid brass and head has a smooth chrome finish

Inlet	Code
Back Inlet Urinal Spreader	364968



DC Pipe Interrupter

DC PIPE INTERRUPTER FOR USE WITH URINALS AND DIRECT FLUSH URINAL SENSORS

- 15mm Inlet / 22mm Outlet
- Prevents bacteria contaminating mains water supply
- For use with urinals & direct flush urinal sensors see pages 62-63

Item	Code
DC Pipe Interrupter	327995

Cistern & Tank Fittings // Flushpipe Bends & Accessories 03

Epson Europipe

SPECIFICALLY DESIGNED TO FIT EUROPEAN STYLED FITTINGS

- 457 x 457mm [18"x18"] 2" [50mm] to 1.¾" [41mm]
- Manufactured from one piece, rigid white PVC, has high strength & rigidity, allowing for a good seal at either end, & maintaining a full flush
- Standard size of 18" x 18" this allows the installer to cut the pipe horizontally or vertically to size, allowing greater flexibility in cistern height installation, & wall to pan distance
- Should you be presented with a more irregular installation problem, on request this flushpipe can be manufactured to a max height of 20" & a maxi wall to pan length of 36"
- Manufactured from one piece, rigid white PVC. On request horizontal length can be increased to a max of 36"



Item	Code
Epson Europipe	363705



PVC Flushbends

PVC LOW LEVEL AND EXTENDED FLUSHBENDS

- Manufactured with a 38mm Outside Diameter
- 90° Swept Bend
- Come supplied with tapered sealing ring

Size	Code
356mm x 229mm x 38mm [14" x 9" x 1.½"]	363656
300mm x 300mm x 38mm [12" x 12" x 1.½"]	363654
406mm x 254mm x 38mm [16" x 10" x 1.½"]	363676
406mm x 356mm x 38mm [16" x 14" x 1.½"]	363677
406mm x 406mm x 38mm [16" x 16" x 1.½"]	363679
457mm x 457mm x 38mm [18" x 18" x 1.½"]	363684
510mm x 510mm x 38mm [20" x 20" x 1.½"]	363686
610mm x 457mm x 38mm [24" x 18" x 1.½"]	363687
610mm x 610mm x 38mm [24" x 24" x 1.½"]	363688
763mm x 457mm x 38mm [30" x 18" x 1.½"]	363691

High Level Backwall

TWO-PIECE FLUSHPIPE MANUFACTURED FROM HIGH QUALITY WHITE PVC

- 1525mm [5"] Pan to Cistern Height
- Different top offsets can be manufactured to order
- Supplied with fitted 45mm flange

Size	Code
1657mm [5'6"] Pan to Cistern Height	363626

High Level Sidewall

THREE-PIECE FLUSHPIPE MANUFACTURED FROM TOP QUALITY WHITE PVC. 32mm BORE

- 1657mm [5'6"] Pan to Cistern Height

Item	Code
High Level Sidewall	363634

Tight Radius Flushbend

90° TIGHT RADIUS

FLUSHBEND MANUFACTURED FROM HIGH QUALITY WHITE PVC

- 457mm x 305mm [18" x 12"]
- 90° Tight Radius
- 38mm Outside Diameter

Item	Code
Tight Radius Flushbend	363683

High Level Two-Piece Flushpipe

MANUFACTURED FROM HIGH QUALITY SEAMLESS BRASS TUBE

- 32mm Bore
- 110mm wall to centre top offset
- 203mm return bend
- 1657mm pan to cistern height
- Chrome Plated

Item	Code
High Level Two-Piece Flushpipe	363628

Low Level Flushpipe

MANUFACTURED FROM HIGH QUALITY SEAMLESS BRASS TUBE

- 408mm x 254mm [16" x 10"]
- Chrome Plated

Size	Code
Low Level Flushpipe	363642

Can be Supplied in Pre-Pack

03 Cistern & Tank Fittings // Flushpipe Bends & Accessories



Buffer Clip
CHROME PLATED DECORATIVE STYLED FLUSHPIPE CLIPS

- Chrome Plated
- High and Low Level Specification

Item	Code
Buffer Clip	363751



Syphon Tail Shroud
BELL SHAPED 35mm SPUN BRASS SYPHON TAIL SHROUD

- High and Low Level Specification
- Chrome Plated

Size	Code
High Level 35mm	363755
Low Level 38mm	363758



Tapered PVC Rings
TO SUIT FLUSHPIPES AND FLUSHBENDS

- Flexible tapered PVC sealing ring for sealing flushpipes or flushbends to syphon

Size	Code
32mm [1.¼"]	367462
38mm [1.½"]	367463
50mm [2"]	367464



EVA/Polythene Flushpipe Connector
EVA/POLYTHENE INTERNAL FIN TYPE

- To fit 38mm [1.½"] Flushpipes
- EVA/Polythene Internal Fin Type

Item	Code
EVA/Polythene Flushpipe Connector	370220



PVC Flushpipe Connector
PVC INTERNAL

- To fit 38mm [1.½"] Flushpipes
- PVC Internal

Item	Code
PVC Flushpipe Connector	370221



Universal Flushpipe Connector
UNIVERSAL - ACCOMMODATES BOTH 1.¼" AND 1.½" FLUSHPIPES

- Universal can fit both 38mm and 32mm [1.¼" and 1.½"]
- Universal External

Item	Code
Universal Flushpipe Connector	363717



European Flushpipe Connector
EUROPEAN TO SUIT 1.¼" FLUSHPIPE

- To suit 41mm [1.½"] Flushpipes
- European to suit 1.¼" pipe

Item	Code
European Flushpipe Connector	370214



Can be Supplied in Pre-Pack

Cistern & Tank Fittings // Close Coupling Kits & Spares 03



Close Coupling Kit
DOUGHNUT WASHER 1.¼" OUTLET

- Supplied with 1.¼" cranked plate, nuts, bolts and a standard rubber doughnut washer
- For cisterns with 1.¼" outlet

Item	Code
Close Coupling Kit	363765



Close Coupling Kit
FLAT PLATE AND IS RING 1.¼" OUTLET

- Supplied with 1.¼" flat plate, nuts, bolts and IS Sealing Ring
- For cisterns with 1.¼" Outlet

Item	Code
Close Coupling Kit	363770



Close Coupling Kit
FOAM WASHER 2" OUTLET

- Supplied with a 2" cranked plate, nuts, bolts and a 2" foam washer
- For cisterns with 2" outlet

Item	Code
Close Coupling Kit	334181



Close Coupling Kit
FOAM WASHER 1.¼" OUTLET

- Supplied with 1.¼" cranked plate, nuts, bolts and a standard washer
- For cisterns with 1.¼" outlet

Item	Code
Close Coupling Kit	363763



Close Coupling Kit
STEPPED WASHER 1.¼" OUTLET

- Supplied with 1.¼" cranked plate, nuts, bolts and a stepped rubber washer
- For cisterns with 1.¼" outlet

Item	Code
Close Coupling Kit	363764



Close Coupling Kit Bolts
CISTERN TO PAN, NUT, BOLT AND WASHER SET

- Supplied with nuts, bolts and washers
- Long type bolts
- Multiple washers to ensure a watertight fit

Item	Code
Close Coupling Kit	363768



Close Coupling Kit Bolts
NUT, BOLT AND WASHERS (PAIR)

- Supplied with nuts, bolts and washers
- Standard size bolts

Item	Code
Close Coupling Kit	363761



Can be Supplied in Pre-Pack

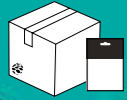

03 Cistern & Tank Fittings // Close Coupling Kits & Spares



Close Coupling Kit Washer DOUGHNUT WASHER

- Manufactured from high-quality strong rubber
- Fits securely between cistern and pan
- To suit 1½" outlet

Item	Code
Close Coupling Kit Washer	367486



Close Coupling Kit Washer FOAM WASHER

- Manufactured from high-quality materials
- Fits securely between cistern and pan
- To suit 1½" outlet

Item	Code
Close Coupling Kit Washer	367491



Close Coupling Kit Washer 2" FOAM WASHER

- 2" Washer [110mm x 69mm x 18mm]
- Manufactured from high-quality materials
- Fits securely between cistern and pan
- To suit 2" outlet

Size	Code
2" Close Coupling Kit Washer	367494



Close Coupling Kit Washer STEPPED WASHER

- Manufactured from high-quality strong rubber
- Fits securely between cistern and pan
- To suit 1½" outlet

Item	Code
Close Coupling Kit Washer	367490



Cistern to Pan Kit Washer SELF CENTRING CONICAL SEALING WASHER

- Manufactured from high-quality materials
- Fits securely between cistern and pan
- To suit 1½" outlet

Item	Code
Close Coupling Kit Washer	367493



Close Coupling Kit Washer IDEAL STANDARD RING

- Ideal Standard, manufactured sealing ring
- Most commonly used with Ideal Standard toilets, but can also be used on other close coupled cisterns

Item	Code
Close Coupling Kit Washer	367488



Overflow 19mm [¾"] TANK CONNECTOR/ CISTERN OVERFLOW

- ¾" BSP

Size	Code
¾" BSP Overflow	367309



Overflow 19mm [¾"] VERTICAL CISTERN OVERFLOW STRAIGHT

- ¾" BSP

Size	Code
¾" BSP Overflow	367308



Overflow 19mm [¾"] VERTICAL CISTERN OVERFLOW OFFSET

- ¾" BSP

Size	Code
¾" BSP Overflow	367307

Pre-Packed Products // Plumbing Boxes 04

NO.1 IMPERIAL O RING PLUMBERS REPAIR KIT BOX

PRE-PACKED PRODUCTS // PLUMBING BOXES

No.1 Imperial O Ring Plumbers Repair Kit Box

Kit Contains:

- 018 'O' Ring x 15
- 119 'O' Ring x 5
- 19 'O' Ring x 15
- 117 'O' Ring x 10
- 115 'O' Ring x 15
- 110 'O' Ring x 15
- 212 'O' Ring x 5
- 025 'O' Ring x 10
- 213 'O' Ring x 5
- 118 'O' Ring x 5
- 119 'O' Ring x 5



Item	Code
No.1 Plumbers Repair Kit Box	367528

NO.2 BALLVALVE PLUMBERS REPAIR KIT BOX

PRE-PACKED PRODUCTS // PLUMBING BOXES

No.2 Ballvalve Plumbers Repair Kit Box

Kit Contains:

- ½" Ballvalve Rubber Washers x 10
- ¾" Ballvalve Rubber Washers x 5
- ½" Ballvalve Seat Fibre x 10
- Small/Medium Brass Split Pins x 2/5
- ¾" Ballvalve Rubber Washers x 10
- 1 ¼" Ballvalve Rubber Washers x 5/5
- High Pressure Ballvalve Rubber Washers x 5
- Aquasave Ballvalve Rubber Washers x 5
- ¾" Ballvalve Rubber Washers x 10
- Ballvalve Stem Washer x 2
- 115 'O' Ring x 2
- Low Pressure Seats x 5



Item	Code
No.2 Plumbers Repair Kit Box	367505

NO.3 TAP WASHER PLUMBERS REPAIR KIT BOX

PRE-PACKED PRODUCTS // PLUMBING BOXES

No.3 Tap Washer Plumbers Repair Kit Box

Kit Contains:

- ¾" Flat Tap Rubber Washers x 10
- ½" Flat Tap Rubber Washers x 10
- ¾" Flat Tap Rubber Washers x 10
- ¾" Flat Tap Rubber Washers x 8
- ½" Tantofex Tap Rubber Washers x 10
- ½" 7/8" Flat Tap and Jumper x 1/1
- ½" Delta Tap Washers x 5
- ½" 7/8" Dome Tap and Jumpers x 2/1
- ¾" Tantofex Tap Rubber Washers x 10
- ½" Pegler/Barking Grohe Tap Washers x 3/2
- ¾" Delta Tap Washers x 5
- ½" ¾" Cap & Liner Washer x 5/5



Item	Code
No.3 Plumbers Repair Kit Box	367542

04 Pre-Packed Products // Plumbing Boxes



NO.4 FIBRE AND RUBBER WASHERS PLUMBERS REPAIR KIT BOX

PRE-PACKED PRODUCTS // PLUMBING BOXES

No.4 Fibre & Rubber Washers Plumbers Repair Kit Box

Kit Contains:

- 1/2" Ballvalve Seat Fibre Washers x 10
- 3/4" Ballvalve Seat Fibre Washers x 5
- 15mm Flexible Tap Connector Washers x 10
- 3/4" Washing Machine Hose Rubber Washer x 10
- 1/2" Top of Tap Body Fibre Washers x 5
- 15mm Fibre Tap Connector Washers x 10
- 22mm Flexible Tap Connector Washers x 10
- 3/4" Top of Tap Body Fibre Washers x 5
- 22mm Fibre Tap Connector Washers x 10
- Bath Shower Divertor/ Washing Machine Hose Filter/ Hot Water Bottle Washers x 5/1/5
- Rubber/ Fibre/ 3/4" Draw Off Tap Washers x 5/5/2



Item	Code
No.4 Plumbers Repair Kit Box	367518

Pre-Packed Products // Plumbing Boxes 04



MEGA PLUMBING BOX

PRE-PACKED PRODUCTS // PLUMBING BOXES

Mega Plumbing Box. Contains 394 Products

Kit Contains:

- Various Tap Washers
- Ballvalve Washers
- Poly Washers
- Various 'O' Rings
- Hose Washers
- Fibre Washers
- Lift Arms
- 1.1/4" Ballvalve Diaphragm Washer
- Bath and Basin Plugs
- Ballvalve Seatings
- Bath and Basin Chain
- Brass Olives
- Cotter Pins
- Radiator Keys
- C Links
- Universal Seat Fixing Kit



Item	Code
Mega Plumbing Box	367556



NO.5 METRIC O RING PLUMBERS REPAIR KIT BOX

PRE-PACKED PRODUCTS // PLUMBING BOXES

No.5 Metric 'O' Ring Plumbers Repair Kit Box

Kit Contains:

- 3mm x 2mm 'O' Ring x 25
- 4mm x 2mm 'O' Ring x 25
- 6mm x 2mm 'O' Ring x 25
- 7mm x 2mm 'O' Ring x 25
- 10mm x 2.5mm 'O' Ring x 20
- 11mm x 2.5mm 'O' Ring x 20
- 12mm x 2.5mm 'O' Ring x 20
- 17mm x 2.5mm 'O' Ring x 20
- 19mm x 2.5mm 'O' Ring x 10
- 19mm x 3mm 'O' Ring x 10
- 20mm x 3mm 'O' Ring x 10
- 24mm x 3mm 'O' Ring x 10



Item	Code
No.5 Plumbers Repair Kit Box	367531



MEGA TAP WASHER BOX

PRE-PACKED PRODUCTS // PLUMBING BOXES

Mega Tap Washer Box. Contains 695 Products

Kit Contains:

- 3/8" Flat Tap Washers x 50
- 1/2" Flat Tap Washers x 100
- 3/8" Flat Tap Washers x 50
- 1/2" Flat Tap Washers x 100
- 3/8" Dome Tap Washers x 25
- 1/2" Dome Tap Washers x 100
- 3/8" Dome Tap Washers x 25
- 1/2" Dome Tap Washers x 45
- 3/8" Delta Tap Washers x 50
- 1/2" Delta Tap Washers x 50
- 3/8" Tantofex Tap Washers x 50
- 1/2" Tantofex Tap Washers x 50



Item	Code
Mega Tap Washer Box	367557



DIAPHRAGM WASHER BOX

PRE-PACKED PRODUCTS // PLUMBING BOXES

24/7 Diaphragm Washer Box

Kit Contains:

- Siamp Diaphragm Washer x 10
- Fluidmaster Standard Seal x 5
- Ballvalve 'O' Ring / Tail Washers x2 / x2
- Wisa Diaphragm Washer x 2
- 1.1/4" Ballvalve Diaphragm Washer x 10
- Wirquin Diaphragm Washer x 2
- Hydroflo Diaphragm Washer x 3
- 1.1/4" Ballvalve Washer x 5
- 1/2" Ballvalve Stem Washer x 5
- 3/8" Ballvalve Washer x 10



Item	Code
Diaphragm Washer Box	367514



MEGA IMPERIAL 'O' RING BOX

PRE-PACKED PRODUCTS // PLUMBING BOXES

Mega Imperial 'O' Ring Plumbers Repair Box. 435 'O' Rings

Kit Contains:

- 006 'O' Ring x 30
- 007 'O' Ring x 30
- 008 'O' Ring x 30
- 009 'O' Ring x 30
- 010 'O' Ring x 30
- 011 'O' Ring x 30
- 012 'O' Ring x 30
- 013 'O' Ring x 20
- 014 'O' Ring x 20
- 015 'O' Ring x 10
- 016 'O' Ring x 10
- 017 'O' Ring x 10
- 018 'O' Ring x 10
- 019 'O' Ring x 10
- 020 'O' Ring x 10
- 021 'O' Ring x 10
- 022 'O' Ring x 10
- 023 'O' Ring x 10
- 024 'O' Ring x 10
- 025 'O' Ring x 10
- 026 'O' Ring x 10
- 027 'O' Ring x 10
- 028 'O' Ring x 10
- 029 'O' Ring x 10
- 030 'O' Ring x 10
- 031 'O' Ring x 10
- 032 'O' Ring x 10
- 033 'O' Ring x 10
- 034 'O' Ring x 10
- 035 'O' Ring x 10
- 036 'O' Ring x 10
- 037 'O' Ring x 10
- 038 'O' Ring x 10
- 039 'O' Ring x 10
- 040 'O' Ring x 10
- 041 'O' Ring x 10
- 042 'O' Ring x 10
- 043 'O' Ring x 10
- 044 'O' Ring x 10
- 045 'O' Ring x 10
- 046 'O' Ring x 10
- 047 'O' Ring x 10
- 048 'O' Ring x 10
- 049 'O' Ring x 10
- 050 'O' Ring x 10
- 051 'O' Ring x 10
- 052 'O' Ring x 10
- 053 'O' Ring x 10
- 054 'O' Ring x 10
- 055 'O' Ring x 10
- 056 'O' Ring x 10
- 057 'O' Ring x 10
- 058 'O' Ring x 10
- 059 'O' Ring x 10
- 060 'O' Ring x 10
- 061 'O' Ring x 10
- 062 'O' Ring x 10
- 063 'O' Ring x 10
- 064 'O' Ring x 10
- 065 'O' Ring x 10
- 066 'O' Ring x 10
- 067 'O' Ring x 10
- 068 'O' Ring x 10
- 069 'O' Ring x 10
- 070 'O' Ring x 10
- 071 'O' Ring x 10
- 072 'O' Ring x 10
- 073 'O' Ring x 10
- 074 'O' Ring x 10
- 075 'O' Ring x 10
- 076 'O' Ring x 10
- 077 'O' Ring x 10
- 078 'O' Ring x 10
- 079 'O' Ring x 10
- 080 'O' Ring x 10
- 081 'O' Ring x 10
- 082 'O' Ring x 10
- 083 'O' Ring x 10
- 084 'O' Ring x 10
- 085 'O' Ring x 10
- 086 'O' Ring x 10
- 087 'O' Ring x 10
- 088 'O' Ring x 10
- 089 'O' Ring x 10
- 090 'O' Ring x 10
- 091 'O' Ring x 10
- 092 'O' Ring x 10
- 093 'O' Ring x 10
- 094 'O' Ring x 10
- 095 'O' Ring x 10
- 096 'O' Ring x 10
- 097 'O' Ring x 10
- 098 'O' Ring x 10
- 099 'O' Ring x 10
- 100 'O' Ring x 10
- 101 'O' Ring x 10
- 102 'O' Ring x 10
- 103 'O' Ring x 10
- 104 'O' Ring x 10
- 105 'O' Ring x 10
- 106 'O' Ring x 10
- 107 'O' Ring x 10
- 108 'O' Ring x 10
- 109 'O' Ring x 10
- 110 'O' Ring x 10
- 111 'O' Ring x 10
- 112 'O' Ring x 10
- 113 'O' Ring x 15
- 114 'O' Ring x 10
- 115 'O' Ring x 10
- 116 'O' Ring x 10
- 117 'O' Ring x 10
- 118 'O' Ring x 5
- 119 'O' Ring x 5
- 120 'O' Ring x 5
- 211 'O' Ring x 5
- 212 'O' Ring x 5
- 213 'O' Ring x 5
- 214 'O' Ring x 5
- 215 'O' Ring x 5
- 216 'O' Ring x 5



Item	Code
Imperial 'O' ring Box	367559

04 Pre-Packed Products // Plumbing Boxes

24 COMPARTMENT 'O' RING BOX

PRE-PACKED PRODUCTS // PLUMBING BOXES

24 Compartment Plumbers Imperial 'O' Ring Box.
295 'O' Rings

Kit Contains:

- 019 'O' Ring x 15
- 020 'O' Ring x 15
- 120 'O' Ring x 15
- 121 'O' Ring x 15
- 122 'O' Ring x 15
- 123 'O' Ring x 15
- 124 'O' Ring x 15
- 125 'O' Ring x 15
- 126 'O' Ring x 15
- 217 'O' Ring x 15
- 218 'O' Ring x 15
- 219 'O' Ring x 15
- 220 'O' Ring x 15
- 221 'O' Ring x 10
- 222 'O' Ring x 10
- 223 'O' Ring x 10
- 224 'O' Ring x 10
- 226 'O' Ring x 10
- 225 'O' Ring x 10
- 325 'O' Ring x 10
- 326 'O' Ring x 10
- 327 'O' Ring x 10
- 328 'O' Ring x 5
- 329 'O' Ring x 5



Item	Code
24 Compartment 'O' Ring Box	367558

ASSORTED IMPERIAL 'O' RING BOX

PRE-PACKED PRODUCTS // PLUMBING BOXES

18 Compartment Plumbers Imperial 'O' Ring Box.
340 'O' Rings

Kit Contains:

- 011 'O' Ring x 20
- 012 'O' Ring x 20
- 013 'O' Ring x 20
- 014 'O' Ring x 20
- 015 'O' Ring x 20
- 016 'O' Ring x 20
- 017 'O' Ring x 20
- 018 'O' Ring x 20
- 111 'O' Ring x 20
- 112 'O' Ring x 20
- 113 'O' Ring x 20
- 114 'O' Ring x 20
- 115 'O' Ring x 20
- 116 'O' Ring x 20
- 117 'O' Ring x 20
- 118 'O' Ring x 20
- 123 'O' Ring x 10
- 124 'O' Ring x 10



Item	Code
Assorted Imperial 'O' Ring Box	367551

ASSORTED WASHER PACK

PRE-PACKED PRODUCTS // PLUMBING BOXES

18 Compartment Assorted Washer Pack
203 Washers.

Kit Contains:

- ½"/¾" Flex Tube Washers x 15/10
- Washing Machine Hose Washers x 10
- ½"/¾" Prestex Washers x 10/10
- Draw off Tap Washers x 15
- Ballvalve Diaphragm Washers x 5
- ¾"/½"/¾"/¾" Flat Tap Washers x 15/30/10/10
- ½"/¾" Ballvalve Seating Washers x 10/10
- ½"/¾" Flexible Tap Connector Washers x 15/10
- ¾" x ¾" Rubber Hot Water Bottle Washers x 10
- ½"/¾" Fibre Tap Body Washer x 5/3



Item	Code
Assorted Washer Pack	367552

Pre-Packed Products // Plumbing Boxes 04

HANDY WASHER PACK

PRE-PACKED PRODUCTS // PLUMBING BOXES

19 Compartment Handy Washer Pack 263 Washers

Kit Contains:

- ½"/¾" Flex Tube Washers x 20/20
- Washing Machine Hose Washers/ Draw off Tap Washers x 20/20
- ½"/¾" Prestex Washers x 20/20
- Ballvalve Diaphragm Washers x 5
- ½"/¾" Flat Tap Washers x 20/10
- Cap & Line Washer 5/5
- ½"/¾" Ballvalve Seating Washers x 20/10
- ½"/¾" Flexible Tap Connector Washers x 20/20
- ½"/¾" Dome Tap Washers x 10/2
- ½"/¾" Dome Tap Washer and Jumper x 3/1
- ½"/¾" Flat Tap Washer and Jumper x 3/2
- ½"/¾" Top Body Washer x 5/2



Item	Code
Handy Washer Pack	367553



04 Pre-Packed Products // Polybag Range

Pre-Packed Products // Polybag Range 04



Brassware & Accessories

BRASSWARE ACCESSORIES - POLYBAG

- A range of high quality Brackets, Pipes and Fittings handily packed in polybags

Type	Pack Qty	Code
Radiator Brackets - set of 4	1	368458
Brass Clock Type Rad Key	1	368888
Rad Key Alloy	2	368890
Rad Key Brass	2	368891
¼" Air Vent	1	368893
½" Air Vent	2	368894
Air Vent Washer, Fibre	5	368763
Radmaster Isolating Rad Tails	1	368354
Pump Gasket	2	368426
1.5M Blue Washing Machine Hose	1	368404
2.5M Blue Washing Machine Hose	1	368407
1.5M Red Washing Machine Hose	1	368405
2.5M Red Washing Machine Hose	1	368408
Flux Brushes	3	374635
Cooker Stability Chain & Hook	1	368456
Mirror Screws	4	374634



Brass | Copper Olives

BRASS OLIVES - POLYBAG

- A range of high quality Brass Olives handily packed in polybags

Size	Pack Qty	Code
8mm Brass Olives	5	368459
10mm Brass Olives	5	368460
15mm Brass Olives	10	368461
¼" Brass Olives	5	368467
22mm Brass Olives	5	368463
28mm Brass Olives	5	368465
15mm Copper Olives	10	368462
22mm Copper Olives	5	368464
28mm Copper Olives	5	368466



Cistern Levers and Accessories

CISTERN LEVERS AND ACCESSORIES - POLYBAG

Type	Pack Qty	Code
E Type Standard Front Lever	1	368541
E Type Side Lever - Plastic Lift Arm	1	368542
D Type Lever - Plastic Lift Arm	1	368540
D Type Lever - Brass Lift Arm	1	377378
D Type Concealed Lever - Brass Adj Lift Arm	1	368539
'X' Type Lever	1	368545
S Type Lever - Plastic Lift Arm	1	368544
Enabler Lever - Plastic Lift Arm	1	368547
100mm Dome Paddle Lever	1	368548
Deluxe Ceramic Lever - Plastic Lift Arm	1	368550
Brass Adjustable Lift Arm	1	368552
Multi-Purpose Lift-Arm	1	368553



Valve Accessories

VALVE ACCESSORIES - POLYBAG

Type	Pack Qty	Code
¾" Ballvalve Washer, Rubber	2	368825
½ x ¾ High Pressure Seating, White	5	368837
¾" Ball Valve Washer, Rubber	2	368827
1.¼" Ballvalve Washer, Rubber	2	368819
High Pressure Piston	2	368842
Large Cotter Pin, Brass	2	368811
Ballvalve Repair Kit Pack	1	368829
½" Small Cotter Pin	2	368809
¾" Ballvalve Seating Washer	5	368834
1.¼" Ballvalve Washer	2	368813
¾" Ballvalve Seating Washer	5	368836
1.¼" Ballvalve Washer	5	368814
½" Ballvalve Tail washer	5	368857
½" Ballvalve Washer, Rubber	5	368820
Red Ballvalve Washer	10	368867
2" Valve Tail Outlet Washer	2	368890



Nuts and Clips

NUTS AND CLIPS - POLYBAG

- A range of high quality Nuts and Clips handily packed in polybags

Type	Pack Qty	Code
15mm Snap in Pipe Clip	5	368600
16-22mm Jolly Hose Clip	2	368881
18-25mm Jolly Hose Clip	2	368885
25-35mm Jolly Hose Clip	2	368886
25-35mm Jolly Hose Clip	10	368887
18-25mm Jubilee Hose Clip	2	368882
15mm Wrap Over Pipe Clip	5	368603
1.½" B.S.P.T Syphon Coupling Nut White	1	368904
½" Jamb Nut Pack	1	368906
15mm Nail In Pipe Clip	6	368610
Flat Spigot Nut	1	368907
Flushpipe Nut & Tapered Washer	Pair	374848



Pillar Tap Washers

PILLAR TAP WASHERS - POLYBAG

Type	Pack Qty	Code
½" Pillar Tap Washer	5	368637
½" Pillar Tap Washer	10	368636
1.¼" Lavatory/Basin Washer	2	368666
1.¼" Lavatory/Basin Washer	5	368663
½" Pillar Tap Washer, C.N.A.F	10	368640
1.¼" Sink Washer	5	368668
½" Pillar Tap Washer, Rubber	10	368644
1.½" Bath Washer	5	368671
½" Pillar Tap Washer, Rubber	5	368647
Assorted Washer Pack	8	368675
¾" Pillar Tap Washer	10	368646
1.½" Sink Washer	5	368677
¾" Pillar Tap Washer, C.N.A.F	10	368650
¾" Pillar Tap Washer, Rubber	10	368654
Universal Top Hat Washer	2	368709
½" Top Hat Washer	2	368705
¾" Top Hat Washer	2	368707
1" Tank Washer	5	368656
1.¼" Bath Washer	5	368661



Flexible Tube & Hose Washers

FLEXIBLE TUBE & HOSE WASHERS - POLYBAG

- A range of high quality flexible Tube and Hose Washers handily packed in polybags

Type	Pack Qty	Code
½" Shower Hose Washer	5	368846
¾" Gauze Filter Washer	2	368853
¾" Washing Machine Washer	5	368851
½" Flexible Tube Washer	10	368867



Flushpipe Accessories

FLUSHPIPE ACCESSORIES - POLYBAG

- A range of high quality Flushpipe Accessories handily packaged in polybags

Type	Pack Qty	Code
White Internal Connector	1	368387
Fin Type Pan Connector	1	368390
32mm Flushpipe Sealing Ring	2	368686
38mm Flushpipe Sealing Ring	2	368687



Hinges, Brackets & Accessories

HINGES, BRACKETS & ACCESSORIES - POLYBAG

- A range of high quality Hinges, Brackets and Accessories handily packed in polybags.

Type	Pack Qty	Code
Basin Brackets	Pair	368627
Universal Fixing Kit	Pair	368633
Sanitary Fixing Kit	1	368630
White Celmec Toilet Seat Hinge	1	368634
Black Celmec Toilet Seat Hinge	1	368635
Pillar Hinges	1	368632
Dudley Outlet Valve Button and Seal Kit	1	368471



Plugs, Chains and Stoppers

PLUGS, CHAINS AND STOPPERS - POLYBAG

- A range of high quality Plugs, Chains and Stoppers handily packed in polybags

Type	Pack Qty	Code
1 ¾" White Waste Plug	2	368562
White Bath Overflow Stopper	1	368578
1.½" White Waste Plug	2	368554
1.¾" White Waste Plug	2	368562
1.½" Black Waste Plug	2	368556
1.¾" Black Waste Plug	2	368563
1.½" & 1.¾" Black Waste Plug	2	368569
Cistern Hole Stopper, Chrome	1	368586
Cister Hole Stopper, White	1	368582

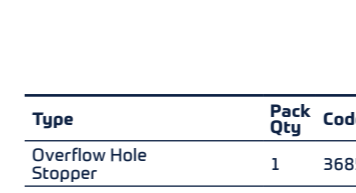

Type	Pack Qty	Code
Overflow Hole Stopper	1	368584
12" Ball Chain Stay & Hook	1	368588
1.½" Plug, CP on Brass & 12" Ball Chain	1	368559
1.¾" Plug, CP on Brass & 18" Ball Chain	1	368565
Bath Overflow Stopper	1	368580
12" Ball Chain - 2 Hooks & Black Waste Plug	1	376528
12" Oval Chain - Stay & Hook	1	368592
18" Oval Chain - Stay & Hook	1	368597
White Tap Hole Stopper	1	368571
18" Ball Chain Stay & Hook	1	368593
18" Ball Chain - 2 Hooks & Black Waste Plug	1	376527
CP Tap Hole Stopper	1	368573
18" Ball Chain c/w 2 Hooks	1	368594
Replacement Pop-Up Basin Plug	1	368898

Miscellaneous Washers

MISCELLANEOUS WASHERS - POLYBAG

Type	Pack Qty	Code
Immersion Heater Washer	1	368877
Bath/Shower Diverter Washer	2	368855
Bath Washer	2	368673
Lrg Immersion Heater Washer	1	368878
Fibre Flex Washers	5	368781
1.¼" Bottle Trap Washer	5	377392
1.½" Fibre Flex Washers	5	377391
Fibre Circulation Pump Washer	2	368860
Rubber Circulation Pump Washer	2	368859
Dudley Outlet Flush Valve Seal	1	368472
Diaphragm Washer [Torbeck]	1	368530
Hydroflo Diaphragm Washer	1	368522

04 Pre-Packed Products // Polybag Range



Cistern | Syphon Accessories
SYPHON ACCESSORIES - POLYBAG

Type	Pack Qty	Code
Nut, Bolt and Washer C.C Kit- Pair	Pair	368392
Mixed Pack Syphon Dia. Washer	10	368699
1.½" Close Coupling Kit with Doughnut Washer	1	368396
2" Close Coupling Kit with Foam Washer	1	368399
1.½" Close Coupling Kit with Flat Washer	1	368394
1.½" Close Coupling Kit with Stepped Washer	1	368395
1.½" Close Coupling Kit with Flat Plate & IS Sealing Ring	1	368398
Cistern To Pan Close Coupling Bolt Set	1	368397
Syvac Aspirator	1	368493
1.½" 'Doughnut' C.C Kit Washer	2	368713
1.½" 'Foam' C.C Kit Washer	1	368716
I.S Ring	1	368714
2" 'Foam' C.C Kit Washer	1	368717
1.½" Syphon Tail Washer, Rubber	2	368691
2" 'C' Link, Small	2	368496
1.½" Syphon Tail Washer, Rubber	2	368693
1" Syphon Tail Washer, Rubber	2	368695
'C' Link Small & Large	2	368498
120mm [4.½"] Round Syphon Dia. Washer	5	368700
130mm [5"] Round Syphon Dia. Washer	5	368703
130mm [5"] Oval Syphon Dia. Washer	5	368696
4" C Link Large	2	368500
Petcock	1	368518
Vertical Cistern Overflow Pipe	1	368598



Tap/Sink Washers
TAP/SINK WASHERS - POLYBAG

Type	Pack Qty	Code
½" Flat Tap Washer c/w Jumper	2	368727
¾" Flat Tap Washer c/w Jumper	2	368729
¾" Flat Tap Washer	5	368731
¾" Prestex Washer	10	368769
½" Flat Tap Washer	5	368735
½" Flat Tap Washer	10	368734
½" Flex Tap Connector Washer	10	368774
¾" Flat Tap Washer	10	368742
¾" Flex Tap Connector Washer	10	368780
¾" Flat Tap Washer	5	368743
½" Delta Tap Washer	5	368789
1" Flat Tap Washer	1	368747
¾" Delta Tap Washer	5	368794
½" Pegler Washer	5	368749
¾" Pegler Washer	5	368753
Supatap 'A' Washer	2	368798
Supatap 'B' Washer	2	368800
½" Dome Tap Washer c/w Jumper	2	368756
Supatap 'D' Washer	2	368802
¾" Dome Tap Washer c/w Jumper	2	368758
½" Tantofex Washer	5	368804
½" Dome Tap Washer	5	368760
¾" Tantofex Washer	5	368807
¾" Dome Tap Washer	5	368762
½" Draw Off Cock Washer	5	368862
½" Prestex Washer	10	368764
32mm Rubber Sink Washer	2	368670
38mm Rubber Sink Washer	2	368680
Flexible Tap Connector Washer	2	368680



Waste/Trap Sealing Washers
TRAP SEALING WASHERS - POLYBAG

Type	Pack Qty	Code
32mm Trap Sealing Ring	2	368682
38mm Trap Sealing Ring	2	368684
32mm Trap Inlet Washer	2	368723
38mm Trap Inlet Washer	2	368725
1.½" Trap Inlet Sealing Washer	5	377394
1.¾" Trap Inlet Sealing Washer	5	377393
Basin Waste Seal Kit	1	368895

Washers & Seals // Tap 05



Top Hat Washers
TO FIT EITHER ½" OR ¾" TAPS

Item	Code
½"/¾" Universal Top Hat Washer	370207
½" Top Hat Washer	367479
¾" Top Hat Washer	367480
Pillar Tap Fixing Washer	367484



Split-Klick Washers
MINIMISES THE RISK OF TAP SPIN

- Manufactured from high quality materials
- Simple but effective product
- To suit ½" taps

Item	Code
Split Kick Top Hat Washer	367483
Split Kick Centralising Washer	367485



Flat Tap Washer comes with Brass Jumper
REPLACEMENT FOR WORN OR LEAKING TAP WASHERS

Size	Code
½"	367841
¾"	367843



Flat Tap Washer
FLAT TAP WASHERS IN VARIOUS SIZES

Size	OD (mm)	ID (mm)	Thickness (mm)	Code
¾"	15.84	4.46	4.5	367845
½"	18.56	4.7	4.5	367851
¾"	21.42	4.87	5	370335
¾"	24.96	4.93	5	367860
1"	30.76	4.73	4	367865



Dome Tap Washer
DOMED TAP WASHERS IN VARIOUS SIZES

Size	OD (mm)	ID (mm)	Thickness (mm)	Code
¾"	15.22	7.05	7	367876
½"	17.08	3.37	9	370334
¾"	19.77	4.55	9	367885
¾"	22.9	5.06	10	367889
1"	29.8	10.2	10	367894



Red Fibre Tap Washer
RED FIBRE FLAT TAP WASHERS. VARIOUS SIZES.

Size	OD (mm)	ID (mm)	Thickness (mm)	Code
¾"	16	3.86	2.85	367927
½"	19.15	4.7	4.2	367928
¾"	22.1	4.5	4.74	367930
¾"	25.5	5	2.9	367931



Dome Tap Washer with Jumper
DOMED TAP WASHERS IN VARIOUS SIZES - WITH PLASTIC JUMPER

- Designed to fit a range of tap sizes

Size	Code
¾"	367871
½"	367872
¾"	367874
¾"	367875



Delta Tap Washer
DELTA (21) TAP WASHER

Size	OD (mm)	ID (mm)	Thickness (mm)	Code
½"	15.64	5.02	5.3	367934
¾"	18.46	4.23	5.12	370344



Tantofex Tap Washer
TANTOFEX TAP WASHER. VARIOUS SIZES

Size	OD (mm)	ID (mm)	Thickness (mm)	Code
½"	16.42	5.63	5	370217
¾"	19.6	5.96	4	367946

05 Washers & Seals // Taps // Cistern // Tank // Trap // Waste

Can be Supplied in Pre-Pack

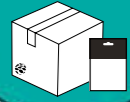

Pegler Tap Washer
PEGLER TAP WASHER. VARIOUS SIZES.

Size	OD (mm)	ID (mm)	Thickness (mm)	Code
½"	15.92	3.8	4.5	370692
¾"	18.06	5.2	4	370693



Top of Tap Washer
TOP OF TAP BODY WASHERS - FIBRE

Type	OD (mm)	ID (mm)	Thickness (mm)	Code
No.1	31.5	28.51	1.5	367950
No.2	30.06	25.34	1.5	367952
No.3	28.47	23.8	1.5	367948
No.4	38.01	31	1.5	367949

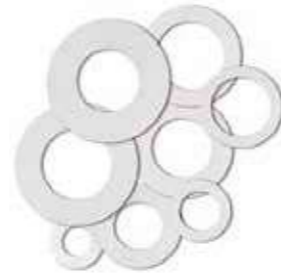

Poly Washers
MANUFACTURED FROM LOW DENSITY POLYTHENE

Size	OD (mm)	ID (mm)	Thickness (mm)	Code
½" Pillar Tap	38	22	1.5	367430
¾" Pillar Tap	44	29	1.5	367435
1" Tank	59	34	1.5	367441
1¼" Lavatory Basin	58	42	1.5	367445
1½" Sink	87	44	1.5	367449
1½" Sink	87	50	1.5	367456
1½" Bath	71	43	1.5	367444
1½" Bath	71	49	1.5	367453



Anti-Rotational Washers
MANUFACTURED FROM PE FOAM 2mm THICK

Size	OD (mm)	ID (mm)	Code
½" Pillar Tap	38	22	367431
¾" Pillar Tap	44	29	367436



Ballvalve Washers
BALLVALVE WASHERS IN VARIOUS SIZES AND TYPES

- Great replacement for any worn washers to suit ballvalves
- Available in a range of sizes
- Manufactured from high quality materials

Size	OD (mm)	Thickness (mm)	Code
¾"	10	3	367980
½"	13	3	367982
½" Low Pressure	13	3	367984
¾"	16	3.5	370336
¾"	19	3	367985
¾" Low Pressure	19	3	367987
¾"	23	3	370218
1"	25	3	367972
1¼"	32	3	367975
1½"	38	3	367978



Ballvalve Seating Washer
BALLVALVE SEATING WASHERS IN VARIOUS SIZES

- Great replacement for any worn washers to suit ballvalves
- Available in either ½" or ¾"
- Manufactured from high quality materials

Size	OD (mm)	ID (mm)	Thickness (mm)	Code
½"	21.94	10.99	1.5	367989
¾"	23.8	16.73	1.5	367991

Washers & Seals // Taps // Cistern // Tank // Trap // Waste 05

Can be Supplied in Pre-Pack



Fibre Washers
1.5mm THICK FIBRE WASHERS

- Epson Holdtite Fibre Washers. Manufactured from C.N.A.F.

Size	OD (mm)	ID (mm)	Thickness (mm)	Code
½" Pillar Tap	38	22	1.5	367432
¾" Pillar Tap	45	28	1.5	367437
1" Tank	65	35	1.5	367442
1¼" Lavatory Basin	60	42	1.5	367446
1½" Sink	83	50	1.5	367457
1½" Sink	88	43	1.5	367450



Trap Inlet Sealing Washer
2mm THICK TRAP INLET SEALING WASHERS IN VARIOUS SIZES

- Available in either 1¼" or 1½"

Size	OD (mm)	ID (mm)	Thickness (mm)	Code
1¼"	38	34	2	367732
1½"	42	38	2	367733



Rubber Washers
RUBBER WASHERS IN VARIOUS SIZES

- Epson Holdtite Rubber Washers

Size	OD (mm)	ID (mm)	Thickness (mm)	Code
½" Pillar Tap	39	21	1.5	367434
¾" Pillar Tap	45	27	2	367439
1¼" Lavatory Basin	57	41	3	367447
1½" Sink	88	43	1.5	367451
1½" Sink	88	50	1.5	367458
1½" Bath	71	48	1.5	367454
1" Tank	63	34	2	367440



Outlet Sealing Washer
TAPERED TRAP OUTLET SEALING WASHER

- Great replacement for any worn washers to suit trap outlets
- Manufactured from high quality materials

Size	Code
1¼"	367460
1½"	367461



Top of Trap Washers
3mm THICK TOP OF TRAP WASHERS IN VARIOUS SIZES

- Great replacement for any worn washers to suit trap outlets
- Available in either 1¼" or 1½"
- Manufactured from high quality materials

Size	OD (mm)	ID (mm)	Thickness (mm)	Code
1¼"	40	32	3	368017
1½"	45	34	3	368018



Bottle Trap Washers
BOTTLE TRAP WASHERS IN VARIOUS SIZES

- Great replacement for any worn washers to suit trap bottle traps
- Available in either 1¼" or 1½"
- Manufactured from high quality materials

Size	OD (mm)	ID (mm)	Thickness (mm)	Code
Bottle Trap 'O' Ring Seal	68	63	2.5	367720
1¼"	40	33	2	368007
1½"	47	40.07	2	368008

Can be Supplied in Pre-Pack

05 Washers & Seals // Central Heating // Service & Hose



Draw Off Tap Washer

RANGE OF RUBBER AND FIBRE DRAW OFF TAP WASHERS

- Available in a range of sizes

Type	OD (mm)	ID (mm)	Thickness (mm)	Code
Rubber	13.82	4.02	3	370337
Fibre	14.84	3.82	2.5	368033
Rubber Type B	12.18	4.25	2.2	368031
Rubber	19	5.10	4.30	368029



Circulation Pump Washer

FIBRE AND RUBBER CIRCULATION PUMP WASHERS

- Available in a range of sizes

Type	OD (mm)	ID (mm)	Thickness (mm)	Code
Rubber	44.31	31.43	3	368026
Fibre	44.31	31.74	2	368027



Immersion Heater Washer

RANGE OF WASHERS FOR IMMERSION HEATERS

- Available in a range of sizes

Type	OD (mm)	ID (mm)	Thickness (mm)	Code
Standard (Fibre)	84	65.96	2	368047
Large (Fibre)	96	67	2.5	368048
Graphite Coated Both Sides (Fibre)	95.4	67	2.5	368049

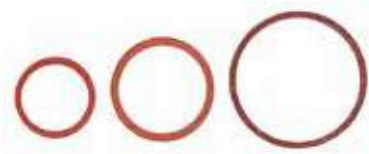

Swivel Washer

PRESTEX '43' SWIVEL WASHERS

- Available in a range of sizes

Type	OD (mm)	ID (mm)	Thickness (mm)	Code
½" (Fibre)	18.25	15	1.75	367908
¾" (Fibre)	23.88	19.85	1.65	367913
1" (Fibre)	31.33	28.67	1.5	367907



Cap and Liner Washer

WRAS APPROVED CAP & LINER WASHER

- Available in either ½" or ¾"

Size	OD (mm)	ID (mm)	Thickness (mm)	Code
½"	18.25	14.74	1.5	367910
¾"	23.6	19.67	1.5	367915



Nylon Tap Connector Washer

NYLON TAP CONNECTOR WASHERS IN MULTIPLE SIZES

- Available in either ½" or ¾"

Size	OD (mm)	ID (mm)	Thickness (mm)	Code
½"	18.45	14.6	2	367911
¾"	23.87	19.5	2	367916

Flexible Tap Connector Washers

FLEXIBLE TAP WASHERS IN VARIOUS STYLES AND SIZES

- Available in either ½" or ¾"

Size	OD (mm)	ID (mm)	Thickness (mm)	Code
½" C.N.A.F.	18.45	11.25	1.5	367919
¾" C.N.A.F.	24.29	14.25	1.5	367922
¾" Rubber	15	7.75	2.5	367918
¾" to suit SF 19mm (¾") Rubber	21	17	2	367926
½" Graphite Coated	19.38	11	1.5	367920
¾" Graphite Coated	24.32	14	1.5	367923
½" to suit SF 13mm (½") Rubber	18	13	2	367925



Cap and Liner Washer

VARIOUS NONE WRAS CAP AND LINER WASHERS

Size	OD (mm)	ID (mm)	Thickness (mm)	Code
½"	18	15	3	368023
¾"	20	17	2.5	368024
¾"	22	17	2.5	368025
¾" Boss Washer	32	26	3	368022

Can be Supplied in Pre-Pack

Washers & Seals // Service & Hose // General // O Rings 05

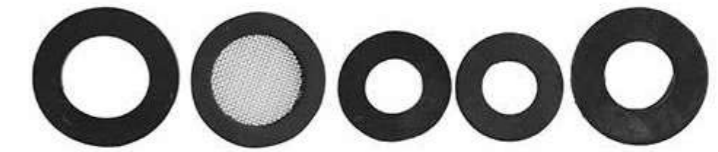

Flexible Tube and Hose Washers

- TUBE AND HOSE WASHERS IN VARIOUS STYLES AND SIZES
- Available in a range of sizes

Type	OD (mm)	ID (mm)	Thickness (mm)	Code
¾" Washing Machine Hose	24	12	2	368011
¾" Gauze Filter to suit Washing Machine Hose	24.08	16	4	368014
½" Shower Hose	19.35	10	2	368009
½" Flexible Tube	20	10	1.7	368034
¾" Flexible Tube	25.75	15	2	368036
Bath/Shower Mixer Diverter	27.45	10	1.5	368019
¾" x ¾" Hot Water Bottle	19.06	9.6	2	368046

Blanking Cap Washers

1.5mm BLANKING CAP WASHERS

- Manufactured from high quality materials
- Available in a range of sizes

Type	OD (mm)	Thickness (mm)	Code
Solid Fibre Disc (small)	18.7	1.5	368053
Solid Fibre Disc (Medium)	23.39	1.5	368055
Solid Fibre Disc (Large)	31.88	1.5	368057

Red Fibre Washers

RED FIBRE WASHERS [1.5mm THICK]

OD (mm)	ID (mm)	Thickness (mm)	Code
9	6.4	1.5	368058
12.6	8.3	1.5	368059
16	10	1.5	368060
17.5	11.5	1.5	368061
19	13.5	1.5	368062
22	14.6	1.5	368063
22	17	1.5	368064

O Rings Imperial

IMPERIAL 'O' RINGS IN VARIOUS SIZES

- O Rings supplied polybagged in packs of 10
- All O Rings are manufactured from Nitrile Rubber 70° Shore A

VISIT OUR WEBSITE FOR THE FULL PRODUCT RANGE



O Rings Metric

METRIC 'O' RINGS IN VARIOUS SIZES

- O Rings supplied polybagged in packs of 10
- All O Rings are manufactured from Nitrile Rubber 70° Shore A

VISIT OUR WEBSITE FOR THE FULL PRODUCT RANGE



Pipes, Valves & Fittings

For every job, there's a precise part that saves the day. Whether you're looking for plumbing pipes, fittings, valves, or something else entirely, you'll find exactly what you need in the full Thomas Dudley Plumbing range.

For live product lead times please visit our website.

Bailey Products [a new brand of the Thomas Dudley family] brings decades of UK-engineered expertise in cable installation and ducting solutions. From telecoms duct rods to the world-renowned Bailey Blue Rod®, our tools are trusted for durability and performance. A select range is now integrated into this category, for the full range of Bailey Products please visit www.bailey-products.com



Bailey

Beta



In this section

01	» Brass Float Valves & Accessories	138	07	» Gas Products	164
02	» Plastic Floats	144	08	» Pipe Clips	166
03	» Compression Pipe Fittings	145	09	» Plumbing Brassware & Accessories	170
	Brass Pipe Fittings	145		Radiator & Heating Products	171
	Chrome Pipe Fittings	149		Washing Machine Accessories	176
04	» Threaded Pipe Fittings	150		Valves	177
05	» Consumables	153		Flexible Tap Connectors	184
06	» Drainage Equipment	154	10	» Water Hammer Arrestors	185
	Drain Rods & Accessories	154			
	Sewer Retrieval Kits	160			
	Telecoms	161			
	Test Plugs	162			



Visit our website

Visit our website and search our extensive range of plumbing parts, find key product information such as technical specifications, installation and troubleshooting guides and create your order all in one place using our Quote Builder function.

01 Brass Float Valves & Accessories

PART 2 SIDE ENTRY BALLVALVE

BRASS FLOAT VALVES & ACCESSORIES // SIDE ENTRY BALLVALVE

- WRAS Approved [Excluding 366892 & 366886]
- To BS1212 Part 2
- Can be supplied with bronze seats, brass backnuts and varying lever lengths
- Recommended float use:
 ½" inlet – 4.½" with ⅝" Thread;
 ¾" inlet – 6" with ⅝" Thread
- Standard Nylon Seat supplied 60°; Bronze Seats 80°



High Pressure: ½" Inlet – 8.3/4" x 3.1/2" Lever, 1/8" Seat	
Size	Code
1.¼" Standard Tail, Brass Backplate	366860
1.¼" Standard Tail, Plastic Backplate	366878
2" Tail, Brass Backplate	366879
3" Tail, Brass Backplate	366880
High Pressure: ¾" Inlet – 8.3/4" x 3.1/2" Lever, 1/4" Seat	
1.½" Standard Tail, Brass Backplate	366886
Low Pressure: ½" Inlet – 8.3/4" x 3.1/2" Lever, 3/8" Seat	
1.¼" Standard Tail, Brass Backplate	330085
2" Tail, Brass Backplate	366898
3" Tail, Brass Backplate	366899
Low Pressure: ¾" Inlet – 8.3/4" x 3.1/2" Lever, 3/8" Seat	
1.½" Standard Tail, Brass Backplate	366892
Medium Pressure: ½" Inlet – 8.3/4" x 3.1/2" Lever, 3/16" Seat	
1.¼" Standard Tail, Brass Backplate	366890



PART 2 BOTTOM ENTRY BALLVALVE

BRASS FLOAT VALVES & ACCESSORIES // BOTTOM ENTRY PART 2 BALLVALVE

- Can be supplied with bronze seats, brass backnut and varying lever lengths
- Standpipe can be supplied straight or offset and in varying lengths
- To BS1212 Part 2
- 9" Height
- Available in both High and Low Pressure specification



High Pressure: ½" Inlet – 8.3/4" x 3.1/2" Lever, 1/8" Seat	
Size	Code
1.¼" Standard Tail, 9" Standpipe	366883
Low Pressure: ½" Inlet – 8.3/4" x 3.1/2" Lever x 3/8" Seat	
Size	Code
1.¼" Standard Tail, 9" Standpipe	366900

Brass Float Valves & Accessories 01

PART 1 SIDE ENTRY BALLVALVE

BRASS FLOAT VALVES & ACCESSORIES // PART 1 SIDE ENTRY BALLVALVE

- To BS1212 Part 1
- Available with bronze seat, brass piston, brass backnut, and varying lever lengths if required
- Recommended float use:
 ½" inlet – 4.½" with ⅝" Thread
 ¾" inlet – 6" with ⅝" Thread



High Pressure: ½" Inlet – 8.3/4" Lever with 5/16 Thread, 1/8" Seat	
Size	Code
1.¼" Standard Tail	366802
2" Tail	366818
3" Tail	366823
Low Pressure: ¾" Inlet – 8.3/4" Lever with 5/16th Thread, 3/8" Seat	
Size	Code
1.½" Standard Tail	366838
2" Tail	366847
3" Tail	366851

PART 1 – 3/4" – 2" INLETS SIDE ENTRY BALLVALVE

BRASS FLOAT VALVES & ACCESSORIES // PART 1.3/4" – 2" INLETS SIDE ENTRY BALLVALVE

- Brass float operated
- Ballvalve supplied with removable seats and brass backnuts
- To suit BS1212 Part 1



High Pressure					
Inlet	Lever	Seat	Piston	Tail	Code
¾"	13"	½"	Nylon	1.½"	366901
¾"	13"	¾"	Nylon	3"	366902
1"	16"	¾"	Brass	1.½"	366836
1.¼"	22"	¾"	Brass	1.¾"	366854
1.½"	22"	¾"	Brass	1.¾"	366856
2"	29"	1"	Brass	2"	366858
Low Pressure					
Inlet	Lever	Seat	Piston	Tail	Code
¾"	13"	½"	Nylon	1.½"	366914
¾"	13"	½"	Nylon	3"	366915
1.¼"	22"	¾"	Brass	1.¾"	366855
2"	29"	1.¼"	Brass	2"	366859

01 Brass Float Valves & Accessories



PART 1 BOTTOM ENTRY BALLVALVE

BRASS FLOAT VALVES & ACCESSORIES // BOTTOM ENTRY PART 1 BALLVALVE

Part 1 Bottom Entry Ballvalve

- To BS1212 Part 1
- 9" Height
- Can be supplied with bronze seat, brass backnut and varying lever lengths. Standpipe can be supplied straight or offset or in varying lengths

High Pressure: ½" Inlet – 8.3/4" Lever, 1/8" Seat	
Size	Code
1.¼" Tail, 9" Standpipe	366832
Low Pressure: ½" Inlet – 8.3/4" Lever x 3/8" Seat	
Size	Code
1.¼" Tail, 9" Standpipe	366853

Drop Arm and Adaptor

ENABLES 'AIR GAP' TO BE ACHIEVED

- Enables the correct 'Air Gap' to be achieved. Available to suit all float operated piston type valves.
- Manufactured from high quality materials
- Designed to help backflow prevention from contamination into clean water supply



Size	Drop	Code
½" BSW Brass Drop Arm	13"	367005
½" BSW Brass Drop Arm	18"	367006
¾" BSW Brass Drop Arm	18"	367007
¾" BSW Brass Drop Arm	12"	367008
¾" BSW Brass Drop Arm	21"	367009
¾" BSW Brass Drop Arm	24"	367010
¾" BSW Brass Drop Arm	24"	367011
¾" BSW Brass Drop Arm	24"	367012
¾" BSW Brass Drop Arm	18"	367013

Float Operated Valve

MOH FLOAT OPERATED VALVE

- Manufactured from high quality materials
- ½" Thread on lever



Inlet	Lever	Seat	Tail	Code
½"	11.¾"	⅜"	1.¾"	366827
¾"	13.¾"	¼"	1.¾"	366908

Brass Float Valves & Accessories 01



Lever Part 1

SUPPLIED WITH LOCKING NUT

- Supplied with locking nut
- Range of sizes to suit all needs
- Manufactured from high quality materials
- Do not bend

Size	Ballvalve Size	Code
8.¾" Standard Lever	½"	366960
10.½" Lever	½"	366962
6" Lever	½"	366976
13" Standard Lever	¾"	366973
8.¾" Lever	¾"	366981
6" Lever	¾"	366984
16" Standard Lever	1"	366982
22" Standard Lever	1.¾" & 1.½"	366964
29" Standard Lever	2"	366983



Lever Part 2

SUPPLIED WITH FLOAT ADJUSTER

- Supplied with Float Adjuster
- Range of sizes to suit all needs
- Manufactured from high quality materials
- Do not bend

Size	Code
8.¾" x 3.¾" for ½" Part 2 Ballvalve	366963



Brass Pistons

PART 1 BRASS PISTONS MADE TO BS1212

- Manufactured from high quality materials
- Supplied complete with washer

Size	Code
½" High Pressure	366989
½" Low Pressure	366990
¾" High/Low Pressure	366993
1" High/Low Pressure	366991
1.¾" & 1.½" High/Low Pressure	366992
2" High/Low Pressure	366994



Cotter Pins

BRASS COTTER PINS

- Suitable for linkage between ballvalve and lever
- Available in a variety of sizes to suit our range of Part 1 and 2 ballvalves

Dia	Fits	Code
½"	Part 2 (½")Ballvalve	367954
¾"	Part 1 (½")Ballvalve	367956
¾"	Part 1 (¾ & 1") Ballvalve	367958
¾"	Part 1 (1.¾" & 1.½") Ballvalve	367960
¾"	Part 1 (2")Ballvalve	367961



Bronze Seat

OPERATES UP TO TEMPERATURES OF 80°

- Manufactured from high quality materials
- Can be ran up to temperatures of 80°

Ballvalve x Seat x Pressure Size	Code
½" x ½" HP	366995
¾" x ¾" HP	366998
¾" x ½" LP	366999
1" x ¾" HP	367000
1.½" & 1.¾" x ¾" HP	367003
1.½" & 1.¾" x 1.¼" LP	367004
2" x 1" HP	367002
2" x 1.¾" LP	367001

01 Brass Float Valves & Accessories



Ballvalve Seatings

½" X ¼" HIGH PRESSURE

- A wide range of pressures and sizes to suit ballvalves
- Manufactured from high-quality materials

Item	Code
Ballvalve Seatings	370219



Ballvalve Seatings

½" X ¼" LOW PRESSURE

- A wide range of pressures and sizes to suit ballvalves
- Manufactured from high-quality materials

Item	Code
Ballvalve Seatings	321754



Ballvalve Seatings

½" X ½" LOW PRESSURE

- A wide range of pressures and sizes to suit ballvalves
- Manufactured from high-quality materials

Item	Code
Ballvalve Seatings	321757



Ballvalve Seatings

½" X ¼" HIGH PRESSURE

- A wide range of pressures and sizes to suit ballvalves
- Manufactured from high-quality materials

Item	Code
Ballvalve Seatings	321756



Ballvalve Seatings

½" X ¼" LOW PRESSURE

- A wide range of pressures and sizes to suit ballvalves
- Manufactured from high-quality materials

Item	Code
Ballvalve Seatings	370215



Ballvalve Seatings

½" X ¼" MEDIUM PRESSURE

- A wide range of pressures and sizes to suit ballvalves
- Manufactured from high-quality materials

Item	Code
Ballvalve Seatings	321753



Ballvalve Piston

½" HIGH PRESSURE

- Manufactured from high quality materials
- Supplied complete with washer

Size	Code
Ballvalve Piston ½" HP Body	368002



Ballvalve Piston

BALLVALVE PISTON ½"/¾" - HIGH/LOW PRESSURE

- Manufactured from high quality materials
- Supplied complete with washer

Size	Code
½" LP Body	370697
¾" HP & LP Body	370696



Spigot Nut

½" SPIGOT NUT

- Manufactured from high quality materials
- ½" BSP
- Internal thread

Item	Code
Spigot Nut	370661

Brass Float Valves & Accessories 01



Screwed Connection

Equilibrium Float Valve

BRONZE BETA EQUILIBRIUM FLOAT VALVE

- Recommended Float Sizes for Beta Equilibrium Ballvalves
- Flow rate chart for Beta Equilibrium Ballvalves
- Copper floats recommended to be used with Equilibriums

Inlet	Lever	Float Thread	Code
1.¼" BSP	11"	¼"	366952
1.½" BSP	11"	¼"	366953
2" BSP	11"	½"	366954
2.½" BSP	19"	¼"	366955
3" BSP	20"	¾"	366956
4" BSP	21"	¾"	366957
6" BSP	23"	¾"	366958



Equilibrium Float Valve

EBCO EQUILIBRIUM FLOAT VALVE

- Full Flow
- Available in ½" to 4"
- BSP or Flanged inlets
- One size of seat and one size of ball float suits any working pressure up to the maximum recommended of 5.0 bar [72 psi]
- Copper floats recommended to be used with Equilibriums

Inlet	Lever	Float Size	Code
Screwed Connection			
½"	10"	4.½" x ¼"	366926
¾"	13"	6" x ¼"	366927
1"	16"	8" x ¼"	366928
1.¼"	17"	8" x ¼"	366929
1.½"	18"	10" x ¼"	366930
2"	19"	12" x ¼"	366931
2.½"	20"	15" x ¼"	366932
3"	21"	15" x ¼"	366933
4"	23"	16" x ¼"	366934

VISIT OUR WEBSITE FOR RECOMMENDED FLOAT SIZES FOR BETA EQUILIBRIUM BALLVALVES



Flanged Connection

Inlet	Lever	Float Size	Code
Flanged Connection			
¾"	13"	6" x ¼"	366935
1"	16"	8" x ¼"	366936
1.¼"	17"	8" x ¼"	366937
1.½"	18"	10" x ¼"	366938
2"	19"	12" x ¼"	366939
3"	21"	15" x ¼"	366940
4"	23"	16" x ¼"	366941



Washer Set

WASHER SET TO SUIT EBCO EQUILIBRIUM BALLVALVES

- Supplied in a range of sizes
- All the washers needed for an equilibrium valve

Size	Code
½"	366943
¾"	366944
1"	366945
1.¼"	366946
1.½"	366947
2"	366948
2.½"	366950
3"	366949
4"	366951



Copper Float

SOLDERED - COLD WATER ONLY

- Soldered
- Cold water only

Size	Code
4.½" x ¼" BSW Stud	366778
5" x ¼" BSW Stud	366779
5.½" x ¼" BSW Stud	366780
6" x ¼" BSW Stud	366781
6" x ¾" BSW Stud	366782
7" x ¼" BSW Stud	366783
8" x ¼" BSW Stud	366784
8" x ¾" BSW Stud	366785
10" x ¼" BSW Stud	366786
12" x ¼" BSW Stud	366787
12" x ¼" BSW Stud	366788
14" x ¼" BSW Stud	366789
15" x ¼" BSW Stud	366790
16" x ¼" BSW Stud	366791

02 Plastic Floats



Elongated Plastic Ball Float 4.5"
4.5" [114mm] ELONGATED BALL FLOAT
• 1/16" Brass Thread

Size	Code
4.5" Elongated Plastic Ball Float	370210



Round Plastic Ball Float 4.5"
4.1/2" [114MM] ROUND BALL FLOAT
• 1/16" Brass Thread

Size	Code
4.5" Round Plastic Ball Float	370209



Round Plastic Ball Float 5"
5" [127mm] ROUND BALL FLOAT
• 1/16" Brass Thread

Size	Code
5" Round Plastic Ball Float	370211



Round Plastic Ball Float 6"
6" [153mm] ROUND BALL FLOAT
• 1/16" Brass Thread

Size	Code
6" Round Plastic Ball Float	370212



Round Plastic Ball Float 8"
8" [203mm] ROUND BALL FLOAT
• 1/16" Brass Thread

Size	Code
8" Round Plastic Ball Float	366794



Round Plastic Ball Float 10"
10" [254mm] ROUND BALL FLOAT
• 1/16" Brass Thread

Size	Code
10" Round Plastic Ball Float	366795

Round Plastic Ball Float 12"
12" [305mm] ROUND BALL FLOAT
• 1/8" Brass Thread

Size	Code
12" Round Plastic Ball Float	366796



For copper floats options please see page 143

Compression Pipe Fittings // Brass 03



Coupler
BRASS COMPRESSION COUPLER IN VARIOUS SIZES

- Suitable for use with hot/cold water and central heating systems
- Manufactured to BSEN1254-2
- WRAS Approved

Size	Code
8mm	364595
10mm	364596
12mm	364597
15mm	364599
22mm	364601
28mm	364603
35mm	364604
42mm	364605
54mm	364606



Slip Coupler
BRASS COMPRESSION SLIP COUPLER AVAILABLE IN SIZES 15mm AND 22mm

- Suitable for use with hot/cold water and central heating systems
- Manufactured to BSEN1254-2
- WRAS Approved

Size	Code
15mm	364607
22mm	364608



Reducing Coupler
BRASS COMPRESSION REDUCING COUPLERS

- Suitable for use with hot/cold water and central heating systems
- Manufactured to BSEN1254-2
- WRAS Approved

Size	Code
10mm x 8mm	364643
15mm x 8mm	364644
15mm x 10mm	364639
15mm x 12mm	364640
22mm x 15mm	364641
28mm x 22mm	364642



FI Coupler
BRASS COMPRESSION FEMALE IRON COUPLERS

- Suitable for use with hot/cold water and central heating systems
- Manufactured to BSEN1254-2
- WRAS Approved

Size	Code
8mm x 1/4"	364633
10mm x 1/4"	364634
10mm x 3/8"	364635
15mm x 1/4"	364636
15mm x 3/8"	364637
15mm x 1/2"	364624
15mm x 3/4"	364626
22mm x 1/2"	364638
22mm x 3/4"	364627
22mm x 1"	364632
28mm x 1"	364628
35mm x 1.1/4"	364629
42mm x 1.1/2"	364630
54mm x 2"	364631



MI Coupler
BRASS COMPRESSION MALE IRON COUPLERS

- Suitable for use with hot/cold water and central heating systems
- Manufactured to BSEN1254-2
- WRAS Approved

Size	Code
8mm x 1/4"	364618
10mm x 1/4"	364619
10mm x 3/8"	364620
15mm x 1/4"	364621
15mm x 3/8"	364622
15mm x 1/2"	364609
15mm x 3/4"	364611
22mm x 1/2"	364623
22mm x 3/4"	364612
22mm x 1"	364613
28mm x 1"	364614
35mm x 1.1/4"	364615
42mm x 1.1/2"	364616
54mm x 2"	364617



Repair Coupler
BRASS COMPRESSION REPAIR COUPLER

- Suitable for use with hot/cold water and central heating systems
- Manufactured to BSEN1254-2
- WRAS Approved

Size	Code
15mm x 15mm x 82mm	364753

03 Compression Pipe Fittings // Brass



Equal Elbow

BRASS COMPRESSION EQUAL ELBOWS

- Suitable for use with hot/cold water and central heating systems
- Manufactured to BSEN1254-2
- WRAS Approved

Size	Code
8mm	364654
10mm	364653
15mm	364657
22mm	364659
28mm	364661
35mm	364662
42mm	364663
54mm	364664



FI Elbow

BRASS COMPRESSION FEMALE IRON ELBOW

- Suitable for use with hot/cold water and central heating systems
- Manufactured to BSEN1254-2
- WRAS Approved

Size	Code
15mm x 1/2"	364676
22mm x 3/4"	364678
22mm x 1"	364679
28mm x 1"	364681
35mm x 1 1/4"	364682
42mm x 1 1/2"	364683
54mm x 2"	364684



MI Elbow

BRASS COMPRESSION MALE IRON ELBOW

- Suitable for use with hot/cold water and central heating systems
- Manufactured to BSEN1254-2
- WRAS Approved

Size	Code
15mm x 1/2"	364666
22mm x 3/4"	364668
22mm x 1"	364669
28mm x 1"	364670
35mm x 1 1/4"	364671
42mm x 1 1/2"	364672
54mm x 2"	364673



Reducing Elbow

BRASS COMPRESSION REDUCING ELBOW

- Suitable for use with hot/cold water and central heating systems
- Manufactured to BSEN1254-2
- WRAS Approved

Size	Code
22mm x 15mm	364665



Reducing Tees

BRASS COMPRESSION REDUCING TEES

- Suitable for use with hot/cold water and central heating systems
- Manufactured to BSEN1254-2
- WRAS Approved

Size	Code
15mm x 15mm x 22mm	364695
22mm x 15mm x 15mm	364696
22mm x 15mm x 22mm	364697
22mm x 22mm x 15mm	364698
28mm x 28mm x 15mm	364699
28mm x 28mm x 22mm	364700
28mm x 22mm x 22mm	364701



Equal Tees

BRASS COMPRESSION EQUAL TEES

- Suitable for use with hot/cold water and central heating systems
- Manufactured to BSEN1254-2
- WRAS Approved

Size	Code
8mm	364694
10mm	364685
15mm	364686
22mm	364688
28mm	364690
35mm	364735
42mm	364692
54mm	364693

Compression Pipe Fittings // Brass 03



Reducing FI Tees

BRASS COMPRESSION FEMALE IRON REDUCING TEES

- Suitable for use with hot/cold water and central heating systems
- Manufactured to BSEN1254-2
- WRAS Approved

Size	Code
15mm x 15mm x 1/2"	364702
22mm x 22mm x 1/2"	364703



Tap Connector

BRASS COMPRESSION TAP CONNECTORS

- Available both angled and straight and in sizes from 15mm to 22mm
- Manufactured to BSEN1254-2
- WRAS Approved

Size	Code
15mm x 1/2" Bent	364740
15mm x 1/2" Straight	364741
22mm x 3/4" Straight	364743



Tank Connector

BRASS COMPRESSION TANK CONNECTORS

- Suitable for use with hot/cold water and central heating systems
- Manufactured to BSEN1254-2
- WRAS Approved

Size	Code
15mm	364744
22mm	364745
28mm	364746
35mm	364747
42mm	364748
54mm	364749



Stop Ends

BRASS COMPRESSION STOP ENDS

- Suitable for use with hot/cold water and central heating systems
- Manufactured to BSEN1254-2
- WRAS Approved

Size	Code
8mm	364738
10mm	364739
15mm	364731
22mm	364733
28mm	364734
35mm	364735
42mm	364736
54mm	364737



Wallplate Elbow

BRASS COMPRESSION WALLPLATE ELBOW

- Suitable for use with hot/cold water and central heating systems
- Manufactured to BSEN1254-2
- WRAS Approved

Size	Code
15mm x 1/2"	364750
22mm x 3/4"	364752



3 Parts Reducers

3 PARTS BRASS REDUCERS. VARIOUS SIZES.

- Suitable for use with hot/cold water and central heating systems
- Manufactured to BSEN1254-2
- WRAS Approved

Size	Code
10mm x 8mm	364648
15mm x 8mm	364649
15mm x 10mm	364650
15mm x 12mm	364651
22mm x 15mm	364645
28mm x 22mm	364646

03 Compression Pipe Fittings // Brass



Copper Olives

COPPER OLIVES IN VARIOUS SIZES

- Suitable for use with hot/cold water and central heating systems
- Manufactured to BSEN1254-2
- WRAS Approved

Size	Code
8mm	364705
10mm	364707
12mm	364709
15mm	364711
20mm	364723
22mm	364713
25mm	364721
28mm	364715
35mm	364717
42mm	364719
54mm	364724
¾" Imperial	364726



Brass Olives

BRASS OLIVES IN VARIOUS SIZES

- Suitable for use with hot/cold water and central heating systems
- Manufactured to BSEN1254-2
- WRAS Approved

Size	Code
8mm	364704
10mm	364706
12mm	364708
15mm	364710
20mm	364722
22mm	364712
25mm	364720
28mm	364714
35mm	364716
42mm	364718
¾" Imperial	364725



1 Part Reducers

BRASS

- Suitable for use with hot/cold water and central heating systems
- Manufactured to BSEN1254-2
- WRAS Approved

Size	Code
22mm x 15mm	364652



Lead Lines

SUPPLIED WITH COMPRESSION OLIVE, NUT AND SEAT

- Suitable for use with hot/cold water and central heating systems
- Manufactured to BSEN1254-2
- WRAS Approved

Size	Code
½" x 6lb x 15mm	364175
½" x 7lb x 15mm	364176
½" x 7lb x 25mm	364178
¾" x 11lb x 25mm	364179
¾" x 9lb x 22mm	364180
¾" x 5lb x 15mm	364181



Compression Nut

BRASS COMPRESSION NUT

- Suitable for use with hot/cold water and central heating systems
- Manufactured to BSEN1254-2
- WRAS Approved

Size	Code
15mm Brass	364727
22mm Brass	364729

Compression Pipe Fittings // Chrome 03



FI | MI Coupler

CHROME PLATED COMPRESSION FEMALE | MALE IRON COUPLER

- Suitable for use with hot/cold water and central heating systems
- Manufactured to BSEN1254-2

Size	Code
FI Coupler - 15mm x ½"	364625
MI Coupler - 15mm x ½"	364610



Compression Coupler

CHROME PLATED COMPRESSION COUPLER

- Suitable for use with hot/cold water and central heating systems
- Manufactured to BSEN1254-2

Size	Code
12mm	364598
15mm	364600
22mm	364602



MI Elbow

CHROME PLATED COMPRESSION MALE IRON ELBOW

- Suitable for use with hot/cold water and central heating systems
- Manufactured to BSEN1254-2

Size	Code
15mm x ½"	364667



FI Elbow

CHROME PLATED COMPRESSION FEMALE IRON ELBOW

- Suitable for use with hot/cold water and central heating systems
- Manufactured to BSEN1254-2

Size	Code
15mm x ½"	364677
22mm x 1"	364680



Equal Elbow

CHROME PLATED COMPRESSION EQUAL ELBOW

- Suitable for use with hot/cold water and central heating systems
- Manufactured to BSEN1254-2

Size	Code
12mm	364656
15mm	364658
22mm	364660



Equal Tees

CHROME PLATED EQUAL TEE

- Suitable for use with hot/cold water and central heating systems
- Manufactured to BSEN1254-2

Size	Code
15mm	364687
22mm	364689



Stop End

CHROME PLATED STOP END

- Suitable for use with hot/cold water and central heating systems
- Manufactured to BSEN1254-2

Size	Code
15mm	364732



Wallplate Elbow

CHROME PLATED WALLPLATE ELBOW

- Suitable for use with hot/cold water and central heating systems
- Manufactured to BSEN1254-2

Size	Code
15mm x ½"	364751



Compression Nuts

CHROME PLATED COMPRESSION NUTS

- Suitable for use with hot/cold water and central heating systems
- Manufactured to BSEN1254-1

Size	Code
15mm	364728
22mm	364730

04 Threaded Pipe Fittings



Hex Bushes

BRASS AND CHROME PLATED HEX BUSHES

- Available in various sizes

Size	Finish	Code
1/4" x 1/8"	Brass	369027
3/8" x 1/4"	Brass	369028
1/2" x 3/8"	Brass	369029
5/8" x 1/2"	Brass	369030
1" x 3/4"	Brass	369031
1 1/2" x 1"	Brass	369032
2" x 1 1/2"	Brass	369033
2 1/2" x 2"	Brass	369034
3" x 2 1/2"	Brass	369035
3 1/2" x 3"	Brass	369037
4" x 3 1/2"	Brass	369038
4 1/2" x 4"	Brass	369039
5" x 4 1/2"	Brass	369040
5 1/2" x 5"	Brass	369041

Size	Finish	Code
1 1/4" x 3/4"	Brass	369042
1 1/2" x 1"	Brass	369043
1 3/4" x 1 1/4"	Brass	369044
2" x 1 1/2"	Brass	369045
2 1/2" x 2"	Brass	369046
3" x 2 1/2"	Brass	369047
3 1/2" x 3"	Brass	369048
4" x 3 1/2"	Brass	369049
4 1/2" x 4"	Brass	369050
5" x 4 1/2"	Brass	369051
5 1/2" x 5"	Brass	369052
6" x 5 1/2"	Brass	369053
6 1/2" x 6"	Chrome Plated	369036



Hex Nipples

BRASS HEX NIPPLES

- Hexagonal body allows easy tightening with standard spanners
- Available in various sizes

Size	Code
1/8"	369127
1/4"	369128
3/8"	369129
1/2"	369130
3/4"	369131
1"	369132
1 1/4"	369133
1 1/2"	369134
2"	369135



Barrel Nipples

BRASS BARREL NIPPLE

- Long, uniform body designed to connect two female threaded fittings
- Fully threaded (BSP male threads) along the entire length
- Smooth internal bore supports consistent flow performance
- High mechanical strength suitable for plumbing and light industrial applications
- Available in various sizes

Size	Code
1/8"	369073
1/4"	369074
3/8"	369075
1/2"	369076
3/4"	369077
1"	369078

Size	Code
1 1/4"	369079
1 1/2"	369082
1" x 3"	369080
1" x 4"	369081
2"	369083



Running Nipples

BRASS RUNNING NIPPLE

- Fully threaded male BSP fitting designed to join two female-threaded connections
- Threaded along the entire length for adjustable engagement depth
- Compact straight design ideal where minimal exposed shank is required
- Smooth internal bore supports consistent flow performance
- Available in various sizes

Size	Code
1/8"	369150
1/4"	369151
3/8"	369152
1/2"	369153
3/4"	369154
1"	369155

Threaded Pipe Fittings 04



Hex Plug

BRASS HEX PLUG

- For Sealing unused outlets on valves, manifolds, pumps, and pipework
- Hexagonal head design for easy tightening with standard tools
- Available in various sizes

Size	Code
1/8"	369136
1/4"	369137
1/2"	369138
3/4"	369139



Flanged Plug

BRASS FLANGED PLUG

- Male BSP threaded plug
- Integral flange provides improved load distribution and sealing support
- Hex head design allows easy installation using standard spanners

Size	Code
1/8"	369106
1/4"	369098
3/8"	369099
1/2"	369100
3/4"	369101
1"	369102
1 1/4"	369103
1 1/2"	369105
2"	369104



Blanking Cap

BRASS | CHROME

- Designed to securely seal the end of a female-threaded fitting or pipe

Size	Finish	Code
1/8"	Brass	369064
1/4"	Brass	369054
3/8"	Brass	369055
1/2"	Brass	369056
3/4"	Brass	369058
1"	Brass	369060
1 1/4"	Brass	369061
1 1/2"	Brass	369062
2"	Brass	369063
1/2"	Chrome	369057
3/4"	Chrome	369059



Backnut

BRASS BACKNUT

Size	Code
1/4"	369084
3/8"	369085
1/2"	369086
3/4" BS - Large Flange	369087
1" BS - Large Flange	369088
1 1/4" BS - Large Flange	369089
1 1/2"	369090
2"	369091
2 1/4"	369093
3"	369094
3 1/4"	369095



Socket

BRASS SOCKET

Size	Code
1/8"	369156
1/4"	369157
3/8"	369158
1/2"	369159
3/4"	369160
1"	369161
1 1/4"	369162
1 1/2"	369163
2"	369164



Taper Plug

BRASS TAPER PLUG

Size	Code
3/8"	369168
1/2"	369169
3/4"	369170
1 1/4"	369171



Tap Extension

BRASS THREADED TAP EXTENSION

Size	Code
1/2"	364222
3/4"	364223



Tee

BRASS THREADED FEMALE EQUAL TEES

Size	Code
1/4"	369165
3/8"	369166
1/2"	369167



Hose Tail

BRASS THREADED HOSE TAIL

Size	Code	Size	Code
1/4" x 1/4"	369140	1" x 1"	369145
3/8" x 3/8"	369141	1 1/4" x 1 1/4"	369146
1/2" x 1/2"	369142	1 1/2" x 1 1/2"	369147
3/4" x 3/4"	369143	2" x 2"	369148

04 Threaded Pipe Fittings



WRAS

Blanking Disk

BRASS BLANKING DISK

- Used to cap and seal the end of a pipe or an unused opening in a plumbing system
- High-quality plumbing fittings
- Suitable for hot and cold water, central heating and gas installations
- Reliable solution for domestic, commercial and industrial plumbing applications

Size	Code
Blanking Disc - 15mm	369065
Blanking Disc - 22mm	369066



Manifold

BRASS 3 WAY END FEED BULLET MANIFOLD

- Distributes water evenly across multiple outlets in plumbing and heating systems
- High-quality brass construction for strength, durability & corrosion resistance
- Suitable for hot and cold water, central heating and sealed system installations
- Ideal for domestic, commercial and industrial plumbing layouts

Size	Code
22mm x 8mm x 2	369067
22mm x 8mm x 3	369068
22mm x 8mm x 4	369069
22mm x 10mm x 2	369070
22mm x 10mm x 3	369071
22mm x 10mm x 4	369072



WRAS

Female Geka Fitting

FEMALE GEKA FITTING

- Quick-connect hose coupling for fast, secure attachment in water and irrigation systems
- Durable brass construction for long-lasting, corrosion-resistant performance
- Compatible with standard Geka claw fittings for leak-free hose connections
- Suitable for domestic, commercial and industrial water transfer applications

Size	Code
½"	369107
¾"	369109
1"	369111



Tail Geka Fitting

HOSE TAIL GEKA FITTING

- Quick-connect hose coupling with integrated hose tail for fast, secure attachment
- Durable brass construction for long-lasting, corrosion-resistant performance
- Compatible with standard Geka claw fittings for reliable, leak-free hose connections
- Suitable for domestic, commercial and industrial water transfer applications

Size	Code
½"	369119
¾"	369121
1"	369123



Male Geka Fitting

MALE GEKA FITTING

- Quick-connect hose coupling with male threaded connection for fast, secure system integration
- Durable brass construction for long-lasting, corrosion-resistant performance
- Compatible with standard Geka claw fittings for reliable, leak-free hose connections
- Suitable for domestic, commercial and industrial water transfer applications

Size	Code
½"	369113
¾"	369115
1"	369117



Geka Washer

WASHER TO SUIT GEKA FITTINGS

- Provides a secure, watertight seal between Geka claw fittings
- Durable rubber construction for long-lasting, leak-resistant performance
- Compatible with all standard Geka hose couplings
- Suitable for domestic, commercial and industrial water transfer applications

Item	Code
Geka Washer	369125

Consumables 05

Can be Supplied in Pre-Pack



WRAS

PTFE Tape

PTFE THREAD SEAL TAPE

- A great way of sealing a thread to ensure that the installation is watertight and no leak will occur

Item	Code
PTFE Tape	364215



WRAS

PTFE Gas Tape

GAS PTFE THREAD SEAL TAPE

- A specialised, high-density thread sealing tape designed specifically for gas lines, LPG, and hydrocarbon services to ensure leak-proof, safe joints

Item	Code
PTFE Gas Tape	364216



Flux Brushes

WOODEN HANDLES

- Fine brushes to reduce damage from corrosive substances
- Pack qty 3

Item	Code
Flux Brushes	374635



Jointing Compound

BOSS JOINTING COMPOUND

- Suitable for use with threaded products that require a watertight seal
- Manufactured from high quality materials

Type	Code
400gm White	364213
400gm Gastite	364214



Flux

LA-CO REGULAR FLUX

- Suitable for use with any copper pipe systems
- Manufactured from high quality materials

Type	Code
2oz LA-CO Regular Flux	364208
4oz LA-CO Regular Flux	364209
1lb LA-CO Regular Flux	364207



Solder

LEADED SOLDER REEL

- Creates strong, reliable joints for copper and brass pipework in plumbing and heating systems
- 500g

Item	Code
Solder	364211



Lead Free Solder

LEAD FREE SOLDER. REEL

- Creates strong, reliable joints for copper and brass pipework in plumbing and heating systems with a Lead-free alloy formulation for safe use in potable water installations
- 500g

Item	Code
Lead Free Solder	329881

Small Pipe Cutter

SMALL PIPE CUTTER. 3mm - 22mm

- Designed for cutting copper, aluminium, brass, and plastic tubing
- Handles tubes ranging from 3mm up to 22mm (¼" to ¾") in diameter

Item	Code
Small Pipe Cutter	363989



06 Drainage Equipment // Drain Rods & Accessories



BAILEY - BLUE POLYPROPYLENE RODS

DRAINAGE EQUIPMENT // POLYPROPYLENE RODS

Blue Polypropylene Rods with Universal & Lockfast Fitting

- Standard, Medium and Heavy Duty Rods with Riveted Brass Ferrules

Set Contents	Fitting	Code	Fitting	Code
Standard Duty - 3/4" Dia x 0.9M [3']	Universal	377957	Lockfast	377961
Standard Duty - 3/4" Dia x 2M	Universal	377956	Lockfast	377950
Medium Duty - 7/8" Dia x 0.9M [3']	Universal	377958	Lockfast	377962
Medium Duty - 7/8" Dia x 2M	Universal	377955	Lockfast	377951
Heavy Duty - 1" Dia x 0.9M [3']	Universal	377959	Lockfast	377963
Heavy Duty - 1" Dia x 2M	Universal	377954	Lockfast	377866
Heavy Duty - 1.1/2" Dia x 0.9M [3']	Universal	377960	Lockfast	377964
Heavy Duty - 1.1/2" Dia x 2M	Universal	377952	Lockfast	377865



BAILEY DRAIN RODS TOOL SETS

DRAINAGE EQUIPMENT // POLYPROPYLENE RODS

High-performance 3/4" drain rod tool sets

- High-quality polypropylene construction with solid brass joints and riveted fittings, available in Universal or Lockfast joint options
- 3/4" standard diameter for general drainage work
- 3' rod length for manageable handling

Set Contents	Fitting	Code	Fitting	Code
2 Tool Set includes: Plunger and Worm Screw	Universal	377967	Lockfast	377965
3 Tool Set includes: Plunger, Scraper and Worm Screw	Universal	378740	Lockfast	378868
4 Tool Set includes: Plunger, Scraper, Worm Screw & Wheel	Universal	377968	Lockfast	377966



BAILEY POLYPROPYLENE RODS

DRAINAGE EQUIPMENT // POLYPROPYLENE RODS

Universal and Lockfast Polypropylene Rods with Riveted Brass Ferrules

- High-quality polypropylene construction with solid brass joints and riveted fittings, available in Universal or Lockfast joint options
- 3/4" standard diameter for general drainage work
- 3' rod length for manageable handling

Set Contents	Fitting	Code	Fitting	Code
3/4" [19mm] Dia x 3ft	Universal	377872	Lockfast	377873
7/8" [22mm] Dia x 3ft	Universal	377907	Lockfast	378873
1" [25mm] Dia x 3ft	Universal	377906	Lockfast	377932



Drainage Equipment // Drain Rods & Accessories 06

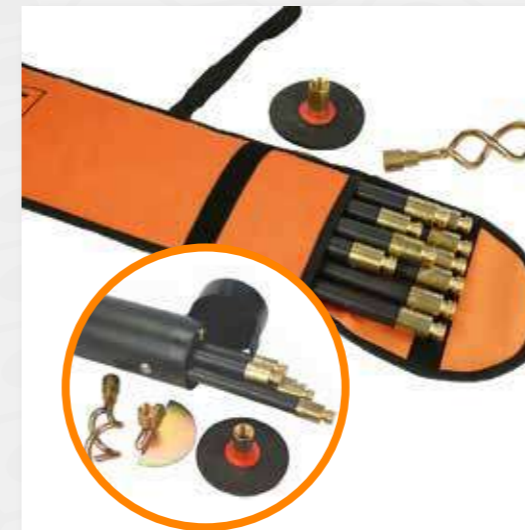

BETA DRAIN MASTER SET

DRAINAGE EQUIPMENT // DRAIN MASTER SET

Universal and Lockfast Fittings in Canvas bag/ Carry Case

- Each set supplied with 10 Polypropylene Rods 3/4" Dia x 3ft with Riveted Brass Ferrules

Set Contents	Bag/Case	Fitting	Code
Plunger and Double Worm	Canvas Bag	Universal	363786
Plunger and Double Worm	Canvas Bag	Lockfast	363787
Plunger and Double Worm	Case	Universal	363788
Plunger, Double Worm & Drop Scraper	Case	Universal	363800
Plunger, Double Worm & Drop Scraper	Case	Lockfast	363802



BETA DRAIN MASTER SET

DRAINAGE EQUIPMENT // DRAIN MASTER SET

Universal and Lockfast Fitting

- Rods strapped together and polybagged
- Each set supplied with 10 Polypropylene Rods 3/4" Dia x 3ft with Riveted Brass Ferrules

Set Contents	Fitting	Code
No tools, rods only	Universal	363815
c/w Plunger and Double Worm	Universal	363785
c/w Plunger, Double Worm and Drop Scraper	Universal	363799
c/w Plunger, Double Worm, Drop Scraper and Guide Wheel	Universal	363822



Set Contents	Fitting	Code
No tools, rods only	Lockfast	363813
c/w Plunger and Double Worm	Lockfast	363793
c/w Plunger, Double Worm and Drop Scraper	Lockfast	363803



BAILEY CHIMNEY RODS

DRAINAGE EQUIPMENT // SWEEP SET

Sweep Set - Universal and Lockfast Fitting

- Bailey Propack Set - 12mm professional nylon rod set for cleaning chimney - triggerlock [10 x trigger lock rods, 1 x 5" brush, 1 x 7" brush, universal and Lockfast rod adaptors]
- See page 157 for Chimney Rod Accessories

Fitting	Code
Bailey Propack - Lockfast Fitting	377870
Triggerlock nylon rod	377871
Male Adaptor	377870



06 Drainage Equipment // Drain Rods & Accessories



Bailey Double Worm Screw

UNIVERSAL AND LOCKFAST FITTING

- For breaking through and extracting stubborn drain blockages such as wipes, paper build-up, rags and organic matter
- Spiral corkscrew design for effectively penetrating blockages

Item	Size	Fitting	Code
Dbl Worm Screw	2"	Universal	378048
Dbl Worm Screw	2"	Lockfast	378040
Dbl Worm Screw	4"	Universal	378051
Dbl Worm Screw	4"	Lockfast	378043



Bailey Rotating Handle

UNIVERSAL AND LOCKFAST FITTING

- Use with rod lengths to allow easier rotation of rods

Item	Fitting	Code
Rotating Handle	Universal	378035
Rotating Handle	Lockfast	378046



Bailey Drop Scraper

UNIVERSAL AND LOCKFAST FITTING

- Used with polypropylene drain rods to remove any obstructions
- A hinged blade passes over obstruction & reverts back to vertical position, allowing obstruction to be dragged back to operator

Size	Fitting	Code
100mm 4" dia	Universal	378058
150mm 6" dia	Universal	378007
100mm 4" dia	Lockfast	378055
150mm 6" dia	Lockfast	378008



Bailey Boring Tool

UNIVERSAL AND LOCKFAST FITTING

- Heavy duty steel boring tool, used with drain rods, for breaking up hard deposits

Item	Fitting	Code
Boring Tool	Universal	378053
Boring Tool Boring	Lockfast	378045



Bailey Clearing Wheel

UNIVERSAL AND LOCKFAST FITTING

- Ideal for guiding rods around bends in pipes
- Removes minor blockages

Item	Fitting	Code
Clearing / Guide Wheel	Universal	378057
Clearing / Guide Wheel	Lockfast	378054



Bailey Harpoon

UNIVERSAL AND LOCKFAST FITTING

- To pierce and extract bulky material for use on drain rods

Item	Fitting	Code
Harpoon	Universal	378052
Harpoon	Lockfast	378044



Bailey Rubber Plunger

UNIVERSAL AND LOCKFAST FITTING

- Designed to efficiently remove blockages from pipes and drains

Size	Fitting	Code
100mm 4" dia	Universal	378049
150mm 6" dia	Universal	378050
100mm 4" dia	Lockfast	378041
150mm 6" dia	Lockfast	378042



Bailey Rubber Plunger c/w Brass Cup & Screw

UNIVERSAL AND LOCKFAST FITTING

- Designed to efficiently remove blockages from pipes and drains
- Brass cup with screw for secure rod attachment

Size	Fitting	Code
100mm 4" dia	Universal	378033
150mm 6" dia	Universal	378056
100mm 4" dia	Lockfast	378034
150mm 6" dia	Lockfast	378024



Beta Force Cup/Plunger

FOR CLEARING BLOCKAGES IN SINKS AND BATHS

- Clears most blockages in sinks and baths
- Safe to use – no harmful chemicals
- Mostly for domestic use

Size	Code
Small	363902
Medium	363901
Large	363900

Drainage Equipment // Drain Rods & Accessories 06



Bailey Sink Cleaner

FOR CLEARING BLOCKAGES IN SINKS, BATHS AND SHOWERS

- Hold gripping handle to clear sink, bath and shower wastes

Size	Code
¼" x 6	378006



Bailey Gully Grab

UNIVERSAL AND LOCKFAST FITTING

- Effective tool for clearing gullies and silt traps

Size	Code
3½"	378699
5½"	378700
6"	377834
8"	378701



Bailey Coiled Spring Rod & Leading Coiled Spring Rod

UNIVERSAL AND LOCKFAST FITTING

- For use where maximum flexibility is required

Item	Code
Coiled Spring Rod - ½" x 3	377844
Coiled Spring Rod - ¾" x 3	377837
Leading Coiled Spring Rod - ½"	378009
Leading Coiled Spring Rod - ¾"	377838



Bailey L/Fast Crown Root Cutter

UNIVERSAL AND LOCKFAST FITTING

- Crown root cutter for cutting roots

Size	Code
4"	378031
6"	378032



Bailey Adaptor for Wire Brushes

UNIVERSAL AND LOCKFAST FITTING

- Whithworth female for use with wire or poly brushes

Joint Type	Fitting	Code
½" WHIT	Universal	377989
½" WHIT	Lockfast	377988



Beta Smoke Matches

BOX OF 12

- White smoke
- 20 second burn time over 1.4m³
- Clean to use, no residue
- Cool to touch after burning
- Harmful if swallowed – keep out of reach of children.
- Do not breathe smoke.
- Manufactured in the UK

Item	Code
Smoke Matches	363917



Beta Drain Cleaning Brushes

UNIVERSAL FITTING

- Our Cleaning Brushes are used together with our polypropylene rods to help clear blockages in drains
- Sturdy bristles for a thorough clean
- Cleaning brush with plastic stock

Size	Fitting	Code
100mm 4" (Drain)	Universal	363868
150mm 6" (Drain)	Universal	363873
200mm 8" (Drain)	Universal	363877
225mm 9" (Drain)	Universal	363879
400mm 16" (Chimney)	Universal	363863



Beta Smoke Pellets

TUBE OF 6

- White smoke
- 40 second burn time over 18m³ of smoke
- Clean to use, no residue
- Cool to touch after burning
- Harmful if swallowed – keep out of reach of children
- Do not breathe smoke

Item	Code
Smoke Pellets	363918



Bailey Chimney Rod Accessories

TRIGGERLOCK, UNIVERSAL & LOCKFAST FITTING

- For use on ceramic flue pipes, pre-cast sectional chimneys and brick chimneys

Item	Fitting	Code
5" Polybrush	Triggerlock	377835
7" Polybrush	Triggerlock	377836
4" Wire Tube Brushes	Universal	378059
6" Wire Tube Brushes	Universal	378060
9" Wire Tube Brushes	Universal	378061
12" Wire Tube Brushes	Universal	378029
16" Wire Tube Brushes	Universal	378062
4" Wire Tube Brushes	Lockfast	378063
6" Wire Tube Brushes	Lockfast	378064
9" Wire Tube Brushes	Lockfast	378702
12" Wire Tube Brushes	Lockfast	378703
16" Wire Tube Brushes	Lockfast	378704

06 Drainage Equipment // Drain Rods & Accessories



BAILEY DRAIN CLEANING BRUSHES

DRAINAGE EQUIPMENT // CLEANING BRUSHES

Bailey Drain Cleaning Brushes are built for tough, effective cleaning across drainage systems, chimneys and flues.

- Available in Lockfast or Universal joint types to suit standard drain rod systems.
- Offered in 4" and 6" brush diameters for a range of cleaning applications.
- Suitable for drain cleaning, chimney sweeping and coal-burning flue maintenance.
- Rigid yet flexible bristle design for effective removal of debris, soot and sediment.
- Ideal for routine maintenance, pre-inspection cleaning and flow restoration.

Nominal Diameter	Universal	Lockfast
4"	377992	378010
6"	378018	378011
8"	378019	378012
9"	378020	378013
10"	378021	378014
12"	378022	378015
14"	378023	378016
16"	377993	378017
Lock Type	Universal	Lockfast
Triggerlock	378003	378002

Drainage Equipment // Drain Rods & Accessories 06



Beta Air Test Bag

AIR TEST BAGS TESTED UP TO 10PSI

- Range of sizes and lengths available
- Inflator pump sold separately
- Manufactured from high quality materials

Size	Type	Code
2"/50mm	Canvas	363937
3"/75mm	Canvas	363938
4"/100mm	Canvas	363939
4"/100mm 3 Metre Long	Canvas	363940
6"/150mm	Canvas	363941
6"/150mm 3 Metre Long	Canvas	363942
9"/225mm	Canvas	363943
2"/50mm	PVC	363841
3"/75mm	PVC	363842
4"/100mm	PVC	363843
6"/150mm	PVC	363844
8"-12"	PVC	363845



Bailey Canvas Air Bag

TESTED UP TO 10PSI

- Inflatable rubber bladder with rubber tubing
- Other sizing available on request

Size	Max Inflation PSI	Brass Tap 1/4"	Schrader Valve
2"/50mm	10	377622	377636
3"/75mm	10	377632	377624
4"/100mm	10	377633	377625
5"/125mm	10	377623	377637
6"/150mm	6	377634	377626
8"/200mm	6	377644	377627
9"/225mm	4	377635	377643
10"/250mm	4	377619	377628
12"/300mm	3	377620	377629



Bailey Inflatable PVC Bags

TESTED UP TO 10PSI

- Inflatable rubber bladder with rubber tubing
- Other sizing available on request

Nominal Size	For Sealing Pipes With Actual Internal Diameters in The Range	Max PSI	Schrader Valve
2" 50mm	but under 3"/75mm	25	377641
3" 75mm	but under 4"/100mm	20	377638
4" 100mm	but under 6"/150mm	15	377630
6" 150mm	but under 8"/200mm	8	377631
8-12" 200-300mm	but under 12.5"/315mm	7	377639

Beta Stopcock Key

STOPCOCK KEY - CRUTCH END/SQUARE END

- A specialised tool used to turn domestic and underground water valves on and off
- Crutch End Key: Designed specifically for valves with a standard crutch-style or T-shaped head
- Square End Key: Fits over valves that have a protruding square spindle



Item	Code
Stopcock Key with Crutch End	363921
Stopcock Key with Square End	363922

Beta Hydrant Standpipe

HYDRANT STANDPIPE SCREWED LONDON THREAD

- A portable vertical pipe used to draw water from underground mains via a fire hydrant
- Features a 2.1/2" female London Round Thread (LRT) inlet - also referred to as London Pattern - that screws directly into standard UK underground hydrant valves



Item	Code
Hydrant Standpipe	363906

Beta Hydrant Key

HYDRANT KEY

- The Hydrant Stand Pipe Key is a heavy-duty steel T-handle tool for operating hydrant valves and standpipes on site and in maintenance workshops
- Steel construction withstands demanding site conditions maintenance workshops

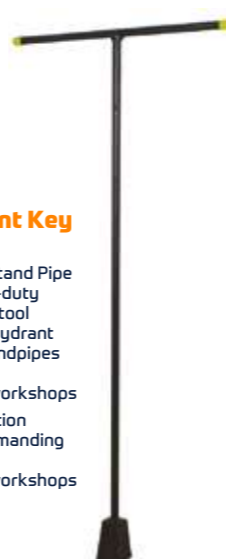

Item	Code
Hydrant Key	363924



Bailey Testing Products

INCLUDING BAILEY DRAIN TEST KIT

- All types of drains
- Test Plugs sold separately

Product	Description	Code
4" 'U' air gauge with label	-	377819
4" 'U' air gauge without label	-	378294
12" 'U' gauge	-	377820
24" 'U' air gauge with adaptor	-	377762
Bailey Drain Test Kit	Air test kit for up to 4" water gauge	377754
Pump for Schrader valve	Plastic pump for Schrader valve	377822



Beta Inflator Pump

FOR INFLATING PVC AND CANVAS AIR BAG

- Manufactured from high quality materials
- Also available in brass

Item	Code
Inflator Pump	363908
Brass Inflator Pump	363909



Bailey Drain Tracing Dye

NON TOXIC - BIODEGRADABLE

- 200gm jar
- Powder form and odourless
- Large range of colours
- Biodegradable
- A quick method of locating leaks in drains

Product	Colour	Code
Drain dye - dilution rates litres 10-12,000	Yellow	377586
Drain dye - dilution rates litres 12-14,000	Purple	377587
Drain dye - dilution rates litres 12-14,000	Blue	377588
Drain dye - dilution rates litres 12-15,000	Red	377585
Drain dye - dilution rates litres 15-20,000	Green	377584
Drain dye - dilution rates litres 20-25,000	Fluoresceine	377583

06 Drainage Equipment // Sewer Retrieval Kit

FEATURED

Bailey Sewer Retrieval Kit

DRAINAGE EQUIPMENT // SEWER RETRIEVAL KIT

The innovative sewer retrieval kit offers the ideal solution for situations when jetting is not working and provides an alternative to more costly disruptive options. The kits have an incredibly high success rate, the high pedigree range of tools create an efficient and straightforward solution that has been carefully designed by a waste water operator within Welsh Water.

- Designed to remove objects from sewer lines when jetting is ineffective
- High success rate with tools developed by a Welsh Water wastewater operator
- Provides a cost-effective alternative to disruptive excavation
- Supplied in a protective hard-shell carry case with foam inserts
- Products included:
100mm Noose Tool, 150mm Noose Tool, Ball Magnet Tool
M10 Lockfast Adaptor, Claw Tool, Scraper Chisel Tool
Root Cutter Tool, Rotary Chisel Tool, Crook Tool
Crook Tool Extension, Single Claw Tool, Noose Tool
Cable Roller, 100 to 150mm 4" to 6" Extension Lug,
½" Male STD Jet Nozzle, ½" Female Swivel Adaptor.



- **If it got in a line, our Sewer Retrieval Kit will get it out**
- **All are included in a carry case for ease of storage**

Visit our website for full product details



For demo videos scan here



Item	Code
Retrieval Tool Kit in Case	377970



Drainage Equipment // Telecoms 06

FEATURED

Telecom Duct Rods

DRAINAGE EQUIPMENT // TELECOMS

The duct rods manufactured by Bailey Products are made from PVC, they are designed to satisfy BT specifications. These rods are fitted with a quality Ferret lock coupling that both ensures total security and quick release of the joint. Fittings are available to suit various applications.

- Range includes straight rods, coiled rods, and multiple diameter options
- Full suite of adaptors, attachments, and couplings available for varied field requirements
- Accessories support joining, leading, following, rigging, and cable threading tasks
- Manufactured in Britain with consistent quality and durability
- ½" and ¾" PVC rods available in 2m, 3m, and 250m coil formats

Item	Description	Code
Duct Rod No. 1	¾" x 3 metre Ferret PVC rod	377590
Duct Rod No. 2	½" x 2 metre Ferret PVC rod	377591
Duct Rod No. 3	¾" x 250 metre coiled PVC rod	377589
Duct Rod No. 4	½" x 250 metre coiled PVC rod	377592



Visit our website for full product details



06 Drainage Equipment // Test Plugs



Bailey Centre Locking Plugs

DRAINAGE EQUIPMENT // TEST PLUGS

Centre Locking Plugs - Designed for reliable drain and pipeline testing, isolation, and maintenance.

- Secure centre-lock mechanism for consistent, evenly distributed expansion
- Available with steel or aluminium plates, paired with brass or plastic caps
- Wide range of nominal pipe sizes with defined min/max operating ranges
- Optional double-seal variants for enhanced pressure retention
- BSP outlet sizes provided for straightforward connection to test equipment
- Suitable for air testing, water testing, isolation and temporary sealing
- Durable brass or steel wing-nut options for operator preference and longevity



- **Manufactured in accordance with BS8301:1985, BS8005:1987 and EN1610:1997**

- **Centre-lock plugs available in steel, aluminium, or nylon**

Operating Pressure Sizes

This is a guide to the maximum back pressure for the different types and sizes of test plugs. These pressures will vary upon cleanliness and condition of pipe bore and ambient temperature.

1/2" (12.5mm) to (30mm)	30 psi
1 1/2" (40mm) to (300mm)	7 psi
1 3/4" (325mm) to (1200mm)	5 psi
Over 40" (1200mm)	3 psi

Nominal Pipe Size [mm]	Nominal Pipe Size [Inches]	BSP Outlet Size	Steel Plates Brass Cap Code	Steel Plates Plastic Cap Code	Aluminium Plates	Min/Max Operating Range	Double Seal Steel Plates Brass Cap Code
Brass Wingnut							
Plastic Cap							
40	1 1/2"	1/2"	377653	377706	377711	36-48	377668
50	2"	1/2"	377654	377704	377712	49-60	377672
65	2 1/2"	1/2"	377655	377707	377713	61-75	377669
75	3"	1/2"	377656	377705	377714	73-85	377673
90	3 1/2"	1/2"	377657	377708	377715	85-95	377670
100	4"	1/2"	377685	377702	377716	94-110	377674
115	4 1/2"	1/2"	377688	377649	377717	110-120	377746
125	5"	1/2"	377658	377647	377718	121-138	377675
140	5 1/2"	1/2"	377739	377738	-	138-148	377740
150	6"	1/2"	377686	377703	377719	146-163	377676
Steel Wingnut							
Brass Cap							
175	7"	1"	377659	-	377720	170-195	377677
200	8"	1"	377660	-	377721	191-211	377678
225	9"	1"	377687	-	377722	216-235	377679
250	10"	1"	377661	-	377723	244-260	377680
275	11"	1"	377648	-	377724	275-305	377671
300	12"	1"	377662	-	377725	296-314	377681
325	13"	1"	377663	-	-	315-350	-
350	14"	1"	377664	-	377726	340-375	377682
375	15"	1"	377665	-	377727	365-400	377683
400	16"	1"	377666	-	377728	390-425	377684
425	17"	1"	377667	-	-	415-440	-
450	18"	1"	377753	-	377729	440-475	-
500	20"	2"	-	-	377747	495-525	-
525	21"	2"	-	-	377748	520-555	-
550	22"	2"	-	-	377730	534-569	-
600	24"	2"	-	-	377749	590-630	-
675	27"	2"	-	-	377750	660-690	-
700	28"	2"	-	-	377751	680-705	-
750	30"	2"	-	-	377752	735-760	-
800	32"	2"	-	-	377709	790-825	-
900	36"	2"	-	-	377710	890-925	-



Drainage Equipment// Test Plugs 06

BAILEY NYLON CENTRE LOCKING PLUGS

DRAINAGE EQUIPMENT // TEST PLUGS

Providing a secure fastening, easy operation, and durable, long-lasting performance.

- Manufactured to BS8301:1985, BS8005:1987 and EN1610:1997, meeting UK and international drain testing standards
- Steel plate strength, durable nylon body & corrosion-resistant cap engineered for repeated use on demanding sites
- Covers 12.7 mm to 150 mm pipes, suitable for domestic, commercial and industrial drain testing



Nominal Pipe Size Metric / [mm]	Nominal Pipe Size Imperial / [Inches]	BSP Outlet Size	Min/Max Operating Range [mm]	Steel Plates Plastic Cap Code
12.7	1/2"	Solid	13-17	377741
19	3/4"	Solid	20-26	377742
25.4	1"	Solid	25-32	377743
32	1 1/4"	Solid	34-43	377744
38	1 1/2"	Solid	38-45	377745
38	1 1/2"	1/2"	38-45	377731
50	2"	1/2"	50-62	377732
65	2 1/2"	1/2"	62-70	377733
75	3"	1/2"	74-87	377734
100	4"	1/2"	97-107	377735
125	5"	1/2"	124-137	377736
150	6"	1/2"	149-165	377737

BAILEY RIM FASTENING PLUGS

DRAINAGE EQUIPMENT // TEST PLUGS

A robust, reliable solution for sealing and testing larger diameter pipelines.

- Heavy-duty steel rim-fast design for secure, stable sealing in large-diameter pipes.
- Available in a wide range of nominal pipe sizes from 450 mm to 1000 mm
- Simple, reliable mechanical expansion for fast installation and removal.
- Manufactured to align with BS8301, BS8005 and EN1610 testing requirements.



Nominal Pipe Size Metric (mm)	Min/Max Operating Range (mm)	Code
450	437-463	378721
475	462-488	378722
500	487-513	377689
525	512-538	378723
600	587-613	377690
675	662-688	377691
700	687-713	377692
750	737-763	377693
800	787-813	377694
850	837-863	377695
900	887-913	377696
1000	987-1013	377698

07 Gas Products



Compression Gas Cock

SELF COLOURED BRASS

- For controlling gas flow, so necessary repairs can be carried out
- Gas easily shut off in the event of emergency
- Manufactured from high quality materials
- Must be fitted by a Gas Safe Registered Engineer

Size	Code
8mm Rigid Fan	364119
8mm CP Rigid Fan	364120
10mm Rigid Fan	364121
15mm Rigid Fan	364122
22mm Rigid Fan	364123



Capillary Gas Cock

SELF COLOURED BRASS CAPILLARY GAS COCK

- For controlling gas flow, so necessary repairs can be carried out
- Gas easily shut off in the event of emergency
- Manufactured from high quality materials
- Must be fitted by a Gas Safe Registered Engineer

Size	Code
8mm Rigid Fan	364124
15mm Rigid Fan	364125
22mm Rigid Fan	364126



Ball Type Gas Cock

EN331 GAS APPROVED BALL TYPE

- For controlling gas flow, so necessary repairs can be carried out
- Gas easily shut off in the event of emergency
- Manufactured from high quality materials
- EN331 Gas Approved Ball Type
- Must be fitted by a Gas Safe Registered Engineer

Size	Code
8mm	364130
10mm	364127
15mm	364129



Pressure Testing Nipple

1/2" PRESSURE TESTING NIPPLE

- 1/2" thread
- Manufactured from high quality materials
- Must be fitted by a Gas Safe Registered Engineer

Size	Code
1/2" Pressure Testing Nipple	364165



Straight Mini Gas Ball Valve

COMPRESSION X COMPRESSION

- Compression x Compression – to EN331. 10 bar, temperature -20° to 85°C
- Compact chrome plated brass ballvalve with yellow coded handle
- For controlling pipe flow, so necessary repairs can be carried out
- Gas easily shut off in the event of emergency
- Manufactured from high quality materials
- Must be fitted by a Gas Safe Registered Engineer

Size	Code
8mm	364146
10mm	364148
15mm	364150



Angled Mini Gas Ball Valve

COMPRESSION X COMPRESSION

- Compression x Compression – to EN331. 10 bar, temperature -20° to 85°C
- Compact chrome plated brass ballvalve with yellow coded handle
- For controlling pipe flow, so necessary repairs can be carried out
- Gas easily shut off in the event of emergency
- Manufactured from high quality materials
- Must be fitted by a Gas Safe Registered Engineer

Size	Code
8mm	364151
10mm	364154



BSP Angle Socket

1/2" BSP ANGLE BAYONET PLUG-IN SOCKET

- Manufactured from high quality materials
- Bayonet fitting
- Must be fitted by a Gas Safe Registered Engineer

Size	Code
1/2" BSP Angle Socket	364132



BSP Straight Socket

1/2" BSP STRAIGHT BAYONET PLUG-IN SOCKET

- Manufactured from high quality materials
- Bayonet fitting
- Must be fitted by a Gas Safe Registered Engineer

Size	Code
1/2" BSP Straight Socket	364133



Micropoint Socket

BRASS MICROPOINT SOCKET

- Manufactured from high quality materials
- Micropoint fitting
- Must be fitted by a Gas Safe Registered Engineer

Size	Code
Micropoint Socket	364160

Gas Products 07

Can be Supplied in Pre-Pack



Gas Meter Union

GAS METER UNIONS MADE TO BS746

- Manufactured from high quality materials

Size	Code
22mm Grooved	364162
28mm Grooved	364163
22/28mm Universal	364161
Meter Union Washer	364164



Catering Hose

APPROVED TO BS669 PART 2 1997

- Manufactured to high specification

Size	Code
1/2" x 1000mm	367297
1/2" x 1000mm Braided	367298
1/2" x 1500mm	367299
1/2" x 1500mm Braided	367300
3/4" x 1000mm	367301
3/4" x 1000mm Braided	367302
3/4" x 1500mm	367303
3/4" x 1500mm Braided	367304
1/2" x 1000mm Bayonet	367305
1/2" x 1250mm Bayonet	367306



Cooker Hose

FOR LPG AND NATURAL GAS

- Manufactured to BS669:1
- Bayonet and Micropoint fitting
- Must be fitted by a Gas Safe Registered Engineer
- Available for LPG and Natural Gas

Type	Size	Fitting	Code
LPG	3ft	Bayonet	364138
LPG	4ft	Bayonet	364137
Natural Gas	3ft	Bayonet	364134
Natural Gas	4ft	Bayonet	364135
Natural Gas	3ft	Micropoint	364156
Natural Gas	3.5ft	Micropoint	364157
Natural Gas	4ft	Micropoint	364158



Cooker Stability Chain

FOR SECURING GAS AND ELECTRIC COOKERS

- Manufactured from high quality materials
- All parts supplied in a bag
- Easy to fit
- Supplied with snap hook for easy release
- Lots of uses around the home and garden
- No accidents with small children or elderly

Item	Code
Cooker Stability Chain	364283



Meter Box Key

FOR OPENING AND CLOSING GAS AND ELECTRIC METER CUPBOARDS

- Manufactured from durable plastic
- Triangular shape for locks
- Hole For Attaching To Keyring

Item	Code
Meter Box Key	364284



Gas Fibre Washers

WASHERS SUITABLE FOR GAS APPLICATIONS

- Green fibre washer, suitable for gas applications

Item	OD (mm)	ID (mm)	QTY (pack)	Thickness	Code
1/4"	10.4	6.26	6	2	368868
3/8"	14.55	8.8	6	2	368869
1/2"	18.38	11.1	8	2	368870
3/4"	23.7	18	6	2	368871
1"	29.7	24	3	2	368872
1.1/2"	38.2	30.3	2	2	368873
1.1/2"	44.4	31.75	2	2	368874
3 x 1/2" - 3 x 3/4" - 1 x 1"			7		368875



Lever Ball Valve F x F

FEMALE X FEMALE GAS LEVER BALLVALVE. YELLOW HANDLE

- Brass body and plated finish
- Female x Female
- For isolating part of the system, this avoids the need to drain down the whole system in order to carry out repairs
- For gas
- Manufactured from high quality materials

Size	Code
1/2"	332976
3/4"	332977
1"	332980
1.1/4"	364189
1.1/2"	364190
2"	364191



Lever Ball Valve Compression

YELLOW HANDLE

- Brass body and plated finish
- Compression x Compression
- For isolating part of the system, this avoids the need to drain down the whole system in order to carry out repairs
- For gas
- Manufactured from high quality materials

Size	Code
15mm	364925
22mm	364926
28mm	364927
35mm	364928
42mm	364929
54mm	364930

Can be Supplied in Pre-Pack

8 Pipe Clips



Snap-in Pipe Clip

INTA-LOC SNAP-IN PIPE CLIP

- Manufactured from high quality materials
- Easily push pipes in to place
- Range of sizes from 15mm, 22mm and 28mm providing plenty of options for all types of installations

Size	Code
15mm	367315
22mm	367316
28mm	367317



Wrap Over Pipe Clips

INTA-LOC WRAP OVER PIPE CLIPS

- Manufactured from high quality materials
- Easily holds pipes in to place
- Range of sizes from 15mm, 22mm and 28mm providing plenty of options for all types of installations

Size	Code
15mm	367318
22mm	367320
28mm	367322



Nail in Pipe Clips

NAIL IN TYPE PIPE CLIPS

- Manufactured from high quality materials
- Easily secure pipes in to place
- Range of sizes from 7-10mm 10-14mm, 15mm and 22mm providing plenty of options for all types of installations

Size	Code
7mm - 10mm	367324
10mm - 14mm	367325
15mm	367326



Hose Clip

BETA HOLDTITE HOSE CLIPS

- Range of sizes from 9.5mm - 160mm

Size	Code
(000) 9½ - 12mm	368100
(M00) 12 - 16mm	368101
(00) 14 - 20mm	368102
(0) 16 - 22mm	368103
(0X) 18 - 25mm	368104
(1A) 22 - 30mm	368105
(1) 25 - 35mm	368106
(1X) 30 - 40mm	368107
(1M) 32 - 45mm	368108
(2A) 35 - 50mm	368109
(2) 42 - 55mm	368110
(2X) 45 - 60mm	368111
(3) 50 - 70mm	368112
(3X) 60 - 80mm	368113
(4) 70 - 90mm	368114
(4X) 80 - 100mm	368115
(5) 100 - 120mm	368116
(6) 125 - 140mm	368117
(7) 140 - 160mm	368118



Jubilee Hose Clip

GENUINE JUBILEE HOSE CLIPS

- Manufactured from stainless steel
- Tested by the British Standards Institute (BSI)
- Carry BS Kitemark™
- Available in a wide range of sizes
- Adjustable to get perfect fit

Size	Code
O0OC12 9½ - 12mm [¾" - ½"]	368065
M0OC16 11 - 16mm [½" - ⅝"]	368067
O0C20 13 - 20mm [½" - ¾"]	368069
OC22 16 - 22mm [⅝" - ⅞"]	368071
OXC25 18 - 25mm [¾" - 1"]	368073
1AC30 22 - 30mm [⅞" - 1¼"]	368075
1C35 25 - 35mm [1" - 1⅜"]	368077
1XC40 30 - 40mm [1⅜" - 1⅝"]	368079
1MC45 [32 - 45mm [1⅜" - 1¾"]	368081
2AC50 35 - 50mm [1⅜" - 1⅞"]	368082
2C55 40 - 55mm [1½" - 2⅜"]	368084
2XC60 45 - 60mm [1⅜" - 2⅜"]	368086
3C70 55 - 70mm [2.0" - 2¾"]	368087
3XC80 60 - 80mm [2⅜" - 3⅜"]	368089
4C90 70 - 90mm [2⅝" - 3½"]	368091
4XC100 85 - 100mm [3¼" - 4.0"]	368092
5C120 90 - 120mm [3⅝" - 4½"]	368094



Hi Grip Hose Clip

BETA HOLDTITE HOSE CLIP WITH THUMBSCREW

- Ideal for use in applications where frequent removal of hoses may be necessary

Size	Code
¾" - 1" [18mm - 25mm]	368119
1⅜" - 1⅝" [30mm - 40mm]	368120

Pipe Clips 8

Can be Supplied in Pre-Pack



Single Munsen Ring

SINGLE MUNSEN RING. BRASS AND CHROME

- Manufactured from high quality materials
- M10
- Larger sizes available

Size	Finish	Code
15mm	Brass	367330
22mm	Brass	367333
28mm	Brass	367336
35mm	Brass	367339
42mm	Brass	367341
54mm	Brass	367343
15mm	Chrome	367331
22mm	Chrome	367334
28mm	Chrome	367337
35mm	Chrome	367340
42mm	Chrome	367342
54mm	Chrome	367344



Double Munsen Ring

BRASS DOUBLE MUNSEN RING

- Helps to secure pipe running along ceilings and walls
- Manufactured from high quality materials
- M10
- Range of sizes from 15mm to 28mm
- Larger sizes available

Size	Code
15mm	367332
22mm	367335
28mm	367338



Copper Saddle Clips

COPPER SADDLE CLIP. VARIOUS SIZES.

- Helps to secure pipe running along ceilings and walls
- Manufactured from high quality materials
- Range of sizes from 15mm to 28mm

Size	Code
15mm	367375
22mm	367377
28mm	367379



2 Piece Copper Saddle Clips

COPPER 2 PIECE SADDLE CLIP

- Helps to secure pipe running along ceilings & walls
- Manufactured from high quality materials
- 15mm

Size	Code
15mm	367380



Chrome Saddle Clips

CHROME SADDLE CLIP - MULTIPLE SIZES

- Helps to secure pipe running along ceilings & walls
- Manufactured from high quality materials
- Sizes include 15mm and 22mm

Size	Code
15mm	367376
22mm	367378



School Board Clip

CAST SCHOOL BOARD CLIP. BRASS AND CHROME AVAILABLE

- Manufactured from high quality materials
- Range of sizes from 15mm to 54mm
- Brass and Chrome

Size	Finish	Code
15mm	Brass	367345
22mm	Brass	367347
28mm	Brass	367349
35mm	Brass	367351
42mm	Brass	367353
54mm	Brass	367355
15mm	Chrome	367346
22mm	Chrome	367348
28mm	Chrome	367350
35mm	Chrome	367352
42mm	Chrome	367354
54mm	Chrome	367356



School Board Clip

PRESSED SCHOOL BOARD CLIP. BRASS AND CHROME

- Manufactured from high quality materials
- Range of sizes from 15mm to 54mm

Size	Finish	Code
15mm	Brass	367357
22mm	Brass	367359
28mm	Brass	367361
35mm	Brass	367363
42mm	Brass	367365
54mm	Brass	367367

Size	Finish	Code
15mm	Chrome	367358
22mm	Chrome	367360
28mm	Chrome	367362
35mm	Chrome	367364
42mm	Chrome	367366
54mm	Chrome	367368

8 Pipe Clips



Backplate
BRASS/CHROME M10 FEMALE IRON BACKPLATE

- FEMALE THREAD
- STANDARD M10 THREAD

Finish	Code
Brass	367381
Chrome	367382



Backplate
BRASS/CHROME M10 MALE IRON BACKPLATE

- MALE THREAD
- STANDARD M10 THREAD

Finish	Code
Brass	367383
Chrome	367384



Mild Steel Clip
RUBBER LINED M8/M10 MILD STEEL CLIPS

- M8/M10 THREAD

Size	Code
12-15mm M8/M10 Threaded	367391
15-19mm M8/M10 Threaded	367392
20-24mm M8/M10 Threaded	367393
25-30mm M8/M10 Threaded	367394



Hospital Bracket
HOSPITAL BRACKET IN BRASS OR CHROME

- Manufactured from high quality materials
- Range of sizes from 15mm to 28mm
- Available in Brass and Chrome

Size	Finish	Code
15mm	Brass	367369
22mm	Brass	367371
28mm	Brass	367373
15mm	Chrome	367370
22mm	Chrome	367372
28mm	Chrome	367374



Dual Purpose Clips
DUAL PURPOSE CLIP, BRASS AND CHROME.

- Manufactured from high quality materials
- Range of sizes from 15mm to 28mm
- Available in Brass and Chrome

Size	Finish	Code
15mm	Brass	367385
22mm	Brass	367387
28mm	Brass	367389
15mm	Chrome	367386
22mm	Chrome	367388
28mm	Chrome	367390

Pipe Clips 8



Flexible Rubber Coupling
FLEXIBLE RUBBER COUPLING, VARIOUS SIZES

- Manufactured from an elastomeric compound
- Stainless Steel Hex Head Screws
- Meets requirements of ASTM C-564

Size	Code
1 1/2" Copper or 1 1/4" PL/ST/LD x 1 1/4" PL/ST/LD	367250
1 1/2" CI/PL/ST/LD x 1 1/2" CI/PL/ST/LD	367251
1 1/2" CI/PL/ST/LD x 1 1/2" CI/PL/ST/LD or 1 1/4" PI/ST/LD	367252
2" x 1 1/2"	367253
2" x 2"	367254
3" x 2"	367255
3" x 3"	367256
4" x 1 1/2"	367257
4" x 2"	367258
4" x 3"	367259

Size	Code
4" x 4"	367260
5" x 4"	367261
5" x 5"	367262
6" x 4"	367263
6" x 5"	367264
6" x 6"	367265
8" x 4"	367266
8" x 6"	367267
8" x 8"	367268
10" x 8"	367269
10" x 10"	367270
12" x 12"	367271



Rubber End Cap
FLEXIBLE RUBBER END CAP

- Manufactured from an elastomeric compound
- Stainless Steel Hex Head Screws
- Meets requirements of ASTM C-564

Size	Code
1 1/2"	367282
2"	367283
3"	367284
4"	367285
5"	367286
6"	367287
8"	367288



Rubber Elbow
FLEXIBLE RUBBER ELBOW

- Manufactured from an elastomeric compound
- Stainless Steel Hex Head Screws
- Meets requirements of ASTM C-564

Size	Code
1 1/2"	367289
2"	367290
3"	367291
4"	367292



Rubber Tees
FLEXIBLE RUBBER TEES

- Manufactured from an elastomeric compound
- Stainless Steel Hex Head Screws
- Meets requirements of ASTM C-564

Size	Code
1 1/2"	367293
2"	367294
3"	367295
4"	367296



Cast Iron/Plastic Rubber Coupling
CAST IRON/PLASTIC FLEXIBLE RUBBER COUPLING

- Manufactured from an elastomeric compound
- Stainless Steel Hex Head Screws
- Meets requirements of ASTM C-564

Size	Code
4" Clay x 4" Cast Iron/Plastic	367272
5" Clay x 5" Cast Iron/Plastic	367273
6" Clay x 4" Cast Iron/Plastic	367274
8" Clay x 6" Cast Iron/Plastic	367276
8" Clay x 8" Cast Iron/Plastic	367277
10" Clay x 10" Cast Iron/Plastic	367278



Rubber Coupling for Drainage
RUBBER COUPLING FOR DRAINAGE

- Manufactured from an elastomeric compound
- Stainless Steel Hex Head Screws
- Meets requirements of ASTM C-564

Size	Code
0.75 or 1" x 1" Dishwasher Connector	367279
1 1/4" x 1 1/2" Tubular Traps Connector (for 1 1/4" or 1 1/2" drain piping)	367280
1 1/4" x 1 1/2" Tubular Traps Connector (for 2" drain piping)	367281

9 Plumbing Brassware & Accessories



Y Strainer

PLUMBING BRASSWARE & ACCESSORIES // VALVES // Y STRAINER

15mm Compression Y Strainer

- 15mm in-line isolating valve
- Double check valve
- Integral removable strainer
- 40 Mesh
- Supplied with both red & blue handles
- 180° rotation
- Suitable for copper & plastic pipe



Type	Code
15mm Compression with Double Check Valve, 40 Mesh	364116

For alternative Y Strainer please see page 181

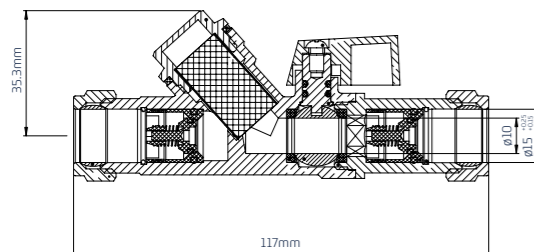

Ideal for isolating both domestic and commercial systems, where particles or sediment may impact the performance or lifespan of the system

- Compact and easy to clean fitted with a removable drain plug
- Ideally suited for applications to protect pumps, meters and valves

Visit our website



Plumbing Brassware & Accessories // Radiator & Heating 9



Angle Radiator Valve

VARIOUS SIZES AVAILABLE

- Brass Body
- Chrome Plated
- Supplied with wheelhead and lockshield tops

Type	Size	Code
Angle	15mm	363945
Angle	10mm	363947
Angle	8mm	363949
Angle with 3/4" Union Tale	15mm	363946
Angle with 3/4" Union Tale	10mm	363948
Angle with 3/4" Union Tale	8mm	363950



Radiator Valve Angle with Drain Off

VARIOUS SIZES AVAILABLE

- Brass Body
- Chrome plated
- Supplied with wheelhead and lockshield tops
- Drain off – quick and easy when emptying the radiator of water

Size	Code
15mm	363953
10mm	363952



Radiator Valve Angle with Rubber Grommet

VARIOUS SIZES

- Chrome Plated
- Supplied with wheelhead and lockshield tops
- Water flow can be easily adjusted by use of a spanner
- Complete with rubber grommet

Size	Code
15mm Wallace Radiator Valve	363967
10mm Wallace Radiator Valve	363968



Straight Radiator Valve

VARIOUS SIZES

- Chrome Plated
- Supplied with wheelhead & lockshield tops

Size	Code
15mm	363954



Brass Angle Radiator Valve

VARIOUS SIZES

- Brass Body
- Supplied with wheelhead & lockshield tops

Size	Code
15mm	363955
8mm	363956



Thermostatic Radiator Valve STRAIGHT

- 15mm Liquid Sensor

Size	Code
15mm	363961

Can be Supplied in Pre-Pack



9 Plumbing Brassware & Accessories // Radiator & Heating



Radiator Tail

ADJUSTABLE RADIATOR TAIL

Size	Code
20mm	363959
40mm	363960



Radiator Brackets

- Supplied in sets of 4
- Fits most standard radiators
- Manufactured from high-quality materials

Item	Code
Radiator Brackets	364285



Alloy Radiator Key

ALLOY RADIATOR KEY WITH SQUARE FEMALE END

Item	Code
Alloy Radiator Key	368126



Clock Type Radiator Key

BRASS CLOCK TYPE WITH SQUARE FEMALE END

Item	Code
Clock Type Radiator Key	368123



Tommy Bar Radiator Key

BRASS TOMMY BAR TYPE WITH SQUARE FEMALE END

Item	Code
Tommy Bar Radiator Key	368127

Radmaster Radiator Tail

ISOLATING RADIATOR TAIL

- The isolation valve is compatible with all systems irrespective of size of inlet /outlet valves
- No need to drain radiator or system
- Fits 15mm (22mm adaptor available)
- Tested and conforms to BS 2767
- Manufactured from solid brass with a high-quality chrome plating
- No airlocks & no need to drain the system
- Isolates radiator from heating system
- One man operation
- Tested to 25 bar
- Quarter-turn for precise open and close positions
- Allen key operation for all round access
- No need to re-pressurize the system
- Tested and conforms to BS2767



Item	Code
Radmaster Radiator Tail 1/2" BSP	368354

Can be Supplied in Pre-Pack



Plumbing Brassware & Accessories // Radiator & Heating 9



Air Vents

3mm [1/8"] WITHOUT KEY

- Brass with BSP male parallel thread
- 10bar max

Size	Code
1/8"	368129



Air Vents

6mm [1/4"] WITHOUT KEY

- Brass with BSP male parallel thread
- 10bar max

Size	Code
1/4"	368131



Air Vents

13mm 1/2" WITHOUT KEY

- Brass with BSP male parallel thread
- 10bar max

Size	Code
1/2"	368133



Air Vents

CAPILLARY AIR VENT

- Brass with BSP male parallel thread
- 10bar max

Size	Code
15mm	364441
22mm	364443



Auto Air Vent

BLASTED BRASS AUTO AIR VENT

- Manufactured from blasted brass
- Automatically does all the work for you
- Supplied with Isolating Valve

Size	Code
1/2" with Isolating Valve	368122
3/8" with Isolating Valve	368121



Air Vents

1/4" CHROME PLATED AUTO AIR VENT

- Brass with BSP male parallel thread
- 10bar max

Size	Code
1/4"	368124

9 Plumbing Brassware & Accessories // Radiator & Heating



Type A Capillary Draincock

VARIOUS SIZES 15MM

- Sturdy brass construction
- Supplied with seal inside body, this keeps the product watertight when not in use
- Lockshield top – no need for a specific key to tighten
- Water flow easily adjusted by use of a spanner

Size	Code
15mm	364028
15mm DZR	364029
15mm DZR Lockshield	364030



Type A Capillary Draincock

15MM LONG SHANK

- Sturdy brass construction
- Supplied with seal inside body, this keeps the product watertight when not in use
- No need for a specific key to tighten
- Water flow can be easily adjusted by use of a spanner

Item	Code
Type A Capillary Long Draincock	364031



Type A Draincock

IN VARIOUS SIZES

- Sturdy brass construction
- Supplied with seal inside body, this keeps the product watertight when not in use
- No need for a specific key to tighten
- Water flow can be easily adjusted by use of a spanner

Size	Code
1/2"	364024
3/4"	364036



Type B Draincock

IN VARIOUS SIZES

- Sturdy brass construction
- No need for a specific key to tighten
- Water flow easily adjusted by use of a spanner

Size	Code
1/2"	364032
15mm	364033



Combi Filling Loop

DZR DOUBLE CHECK VALVE

- Manufactured from high quality materials
- DZR double check valve connected to either straight or tee brass isolating valve

Type	Code
Tee	368957
Straight	368958
Part 'L'	368959



Gate Type Pump Valve

BRASS GATE TYPE PUMP VALVE

- Manufactured from high quality materials
- Supplied with fibre washers
- Suitable for water
- Adjustable flow control

Size	Code
22mm	364061
28mm	364062

Plumbing Brassware & Accessories // Radiator & Heating 9



Ball Type Pump Valve

BALL TYPE PUMP VALVE

- Manufactured from high quality materials
- Supplied with fibre washers
- Suitable for water

Size	Code
22mm	364063
28mm	364064



Pump Valve Fitting Nuts

BRASS NUT

- Manufactured from high quality materials
- Suitable for water

Item	Code
Pump Valve Fitting Brass Nuts	364065



Pump Union

1 1/2" x 1" BRASS PUMP UNION

- Manufactured from high quality materials
- Supplied with fibre washers
- Suitable for water

Size	Code
1 1/2" x 1" Brass Pump Union	364066



Short Adapter

1 1/2" SHORT ADAPTOR

- Manufactured from high quality materials
- Supplied with fibre washers
- Suitable for water

Size	Code
1 1/2" Short Adapter	364067



Extension Pump Union

EXTENSION PUMP UNION

- Manufactured from high quality materials
- Supplied with fibre washers
- Suitable for water

Item	Code
Extension Pump Union	364069



Pump Gasket

1 1/2" PUMP GASKET

- Manufactured from high quality materials
- Suitable for water

Size	Code
1 1/2" Pump Gasket (fibre)	364070



Spring Safety Valves

SAFETY VALVE OPERATED BY INTERNAL SPRING

- Manufactured from high quality materials
- Operated by an internal spring
- Valve vents if set pressure is exceeded
- Internal spring operated
- Maximum opening pressure between 4-5 bar

Size	Code
1/2"	364085
3/4"	364086



Immersion Heater Plug

COPPER CYLINDER IMMERSION HEATER PLUG

- For use in copper cylinders
- Size 2 3/4"
- Accessories available

Size	Code
2 3/4" Immersion Heater Plug (comes with fibre washer)	364087

Can be Supplied in Pre-Pack

9 Plumbing Brassware & Accessories // Washing Machine



Washing Machine Taps

WASHING MACHINE TAPS SUPPLIED WITH RED AND BLUE HANDLES

- Brass Body, Chrome Plated
- Supplied with red and blue handles
- 15mm x 3/4" BSP
- Suitable for both hot and cold water

Type	Code
Straight	
Straight Light Pattern	363971
Straight Heavy Pattern	363973
Straight with Single Check Valve	363985
Angle	
WRAS approved Angle Washing Machine Taps	363976
Tee	
WRAS approved Tee Washing Machine Taps	363977



Self Cutting Washing Machine Tap

SELF CUTTING WASHING MACHINE TAP. 15mm STRAIGHT

- A quick and easy way to install a washing machine tap
- Fits standard 15mm copper pipe
- Suitable for both hot and cold water

Item	Code
Self Cutting Washing Machine Tap	363972



Blue / Red Washing Machine Hose

BLUE/RED WASHING MACHINE HOSE. UNIVERSAL TO FIT WASHING MACHINE/DISHWASHER

Size	Code
1.5m Blue	363978
2.5m Blue	363981
1.5m Red	363979
2.5m Red	363982



Grey Outlet Hose

WASHING MACHINE/DISHWASHER OUTLET HOSE

Size	Code
1.5m	363986
2.5m	363987



Plumbing Out Kit

SUITABLE FOR 32mm & 40mm WASTE CONNECTIONS

- Supplied with easy boring all steel cutter
- Built in non return valve to prevent back flow and drainage smells

Size	Code
Plumbing Out Kit	363988



Y Adaptor

UNIVERSAL TO FIT WASHING MACHINE / DISHWASHER

- Universal to fit washing machine/dishwasher
- Allows 2 appliances to use the same water supply

Size	Code
3/4" BSP Y Adaptor	363980



Outlet Hose Connector

EXTENDER FOR WASHING MACHINE/ DISHWASHER WASTE OUTLET

- Designed to extend a washing machine or dishwasher waster outlet
- Size: 17mm
- Simple and easy to fit - push fit no tools required
- Recommend using our genuine Jubilee Hose Clips to help secure hose

Size	Code
17mm Outlet Hose Connector	363984



Inlet Hose Connector

DESIGNED TO JOIN TWO WASHING MACHINE HOSES TOGETHER

- Size: 3/4"

Size	Code
3/4" Inlet Hose Connector	363983

Plumbing Brassware & Accessories // Valves 9



Chrome Isolating Valve

CHROME COMPRESSION X COMPRESSION ISOLATING VALVE. VARIOUS SIZES

- Compression x Compression
- For isolating part of the system, this avoids the need to drain down the whole system in order to carry out repairs
- Manufactured from high quality materials

Size	Code
15mm Light Pattern with Screw Slot	364052
22mm with Screw Slot	364047
15mm Angled with Screw Slot	364053



Chrome Full Bore Isolating Valve

CHROME COMPRESSION X COMPRESSION FULL BORE ISOLATING VALVE

- Compression x Compression
- For isolating part of the system, this avoids the need to drain down the whole system in order to carry out repairs
- Manufactured from high quality materials

Size	Code
15mm with Screw Slot	364039
22mm with Screw Slot	364048



Chrome Isolating Valve with Handle

CHROME COMPRESSION X COMPRESSION ISOLATING VALVE WITH HANDLE

- Compression x Compression
- For isolating part of the system, this avoids the need to drain down the whole system in order to carry out repairs
- Manufactured from high quality materials

Size	Code
15mm Light Pattern	364054
15mm	364042
22mm	364049



Full Bore Isolating Valve

BRASS COMPRESSION X COMPRESSION FULL BORE ISOLATING VALVE

- Compression x Compression
- For isolating part of the system, this avoids the need to drain down the whole system in order to carry out repairs.
- Manufactured from high quality materials
- 15mm Full Bore with Screw Slot

Size	Code
15mm	364037



Isolating Valve

BRASS COMPRESSION X COMPRESSION ISOLATING VALVE

Size	Code
15mm Light Pattern with Screw Slot	364050
22mm with Screw Slot	364043



Isolating Valve with Handle

BRASS COMPRESSION X COMPRESSION ISOLATING VALVE WITH HANDLE

- Compression x Compression
- For isolating part of the system, this avoids the need to drain down the whole system in order to carry out repairs
- Manufactured from high quality materials

Size	Code
15mm Light Pattern	364051
22mm	364046



Straight Service Valve

CHROME STRAIGHT SERVICE VALVE

- Compression x Swivel Nut
- Screwdriver Slot
- Used to isolate part of the system
- Brass body, chrome plated

Size	Code
15mm x 1/2"	364055
22mm x 3/4"	364081



Push Fit Service Valve

CHROME STRAIGHT PUSH FIT

- Screwdriver Slot
- Used to isolate part of the system
- Brass body, chrome plated

Size	Code
15mm	364056



WRAS Straight Service Valve

CHROME WRAS APPROVED STRAIGHT

- Compression x Swivel Nut
- Screwdriver Slot
- Used to isolate part of the system
- Brass body, chrome plated

Size	Code
15mm x 1/2"	364057

9 Plumbing Brassware & Accessories // Valves

Plumbing Brassware & Accessories // Valves 9



WRAS Angle Service Valve

CHROME WRAS APPROVED ANGLE

- Compression x Swivel Nut
- Screwdriver Slot
- Used to isolate part of the system
- Brass body, chrome plated
- WRAS Approved

Size	Code
15mm x 1/2"	364059



Checkvalve

SINGLE BRASS COMPRESSION X COMPRESSION

- Brass spring loaded
- Compression x Compression
- Fully self automating valve
- Eliminates water contamination or back flow

Size	Code
15mm	364072
22mm	364073
28mm	364074



Checkvalve

FULL BORE

- Prevents reverse flow to protect plumbing and heating systems from backflow
- Used in general plumbing, heating systems, and domestic applications

Size	Code
28mm	364075



Checkvalve

DOUBLE DZR COMPRESSION X COMPRESSION

- Compression x Compression
- DZR
- Fully self automating valve
- Eliminates water contamination or back flow

Size	Code
15mm	364076
22mm	364078



Checkvalve

DOUBLE DZR FEMALE X FEMALE

- DZR
- Female x Female
- Fully self automating valve
- Eliminates water contamination or back flow

Size	Code
3/4" Checkvalve	364079



Wallplate Connector & Kit

- 1/2" female threaded tap mounting flange
- 15mm copper tube
- Available in 14" or 20" length
- Simple DIY installation

Size	Code
14" Copper Tube	364022
20" Copper Tube	364023



Standard Outdoor Tap Kit

STANDARD KIT CONTAINING 9 PIECES

- Simple DIY installation; a quick and easy way of installing a water supply outside of the home
- 1 x Compression Elbow
- 1 x Isolating Valve with Handle
- 1 x Compression Tee Joint
- 1 x Hose Union Bibtap with double check valve
- 1 x Wallplate with Copper Tube
- 3 x Screws and Plugs
- 1 x Roll of PTFE Tape

Item	Code
Standard Outdoor Tap Kit	364017



Economy Outdoor Tap Kit

ECONOMY KIT CONTAINING 5 PIECES

- Simple DIY installation; a quick and easy way of installing a water supply outside of the home
- 1 x 15mm Tee Isolating Valve Brass with double check valve
- 1 x 15mm x 1/2" (500mm long x 7.5mm) bore Flexi Connector
- 1 x 1/2" BS1010 Hose Union Bibtap
- 1 x Wallplate with Copper Tube
- 1 x Roll of PTFE Tape

Item	Code
Economy Outdoor Tap Kit	364006



Hose Union Bibcocks

MADE TO BRITISH STANDARD BS1010

- Manufactured to British Standard BS1010
- For outdoor taps

Size	Code
1/2"	364005
3/4"	364012



DZR Hose Union Bibcocks

DOUBLE CHECK VALVE DZR

- Supplied with internal double check valve
- For outdoor taps

Size	Code
1/2"	364016
3/4"	364020



Tail and Union

HOSE UNION BIBCOCK TAIL AND UNION

- Typically used to connect a standard garden hose to an outside tap
- The set includes a barbed tail connector (or "nozzle") for the hose and a knurled nut for securing it to a tap

Size	Code
To suit 1/2"	364010
To suit 3/4"	364014

9 Plumbing Brassware & Accessories // Valves



Lever Ballvalve Compression

RED HANDLE LEVER BALLVALVE - COMPRESSION

- Brass body and plated finish
- Compression x Compression
- For isolating part of the system, this avoids the need to drain down the whole system in order to carry out repairs.
- For hot water
- Manufactured from high quality materials

Size	Code
15mm	364904
22mm	332979
28mm	364906
35mm	364907
42mm	364908
54mm	364909



Lever Ballvalve Compression

RED BUTTERFLY HANDLE LEVER BALLVALVE - COMPRESSION

- Brass body and plated finish
- Compression x Compression
- For isolating part of the system, this avoids the need to drain down the whole system in order to carry out repairs.
- For hot water
- Manufactured from high quality materials

Size	Code
15mm	332974
22mm	364911



Lever Ballvalve Female x Female

RED HANDLE LEVER BALLVALVE - FEMALE X FEMALE

- Brass body and plated finish
- For isolating part of the system, this avoids the need to drain down the whole system in order to carry out repairs.
- For hot water
- Manufactured from high quality materials
- Female x Female

Size	Code
1/4"	364912
3/8"	364913
1/2"	364914
3/4"	364915
1"	364916
1 1/4"	364917
1 1/2"	364918
2"	364919



Lever Ballvalve Female x Female

RED BUTTERFLY HANDLE LEVER BALLVALVE - FEMALE X FEMALE

- For isolating part of the system, this avoids the need to drain down the whole system in order to carry out repairs.
- For hot water
- Manufactured from high quality materials
- Female x Female

Size	Code
1/2"	364920
3/4"	364921



Lever Ballvalve Compression

BLUE HANDLE LEVER BALLVALVE - COMPRESSION

- Brass body and plated finish
- Compression x Compression
- For isolating part of the system, this avoids the need to drain down the whole system in order to carry out repairs.
- For cold water
- Manufactured from high quality materials

Size	Code
15mm	364886
22mm	332978
28mm	364888
35mm	364889
42mm	364890
54mm	364891



Lever Ballvalve Female x Female

BLUE BUTTERFLY HANDLE LEVER BALLVALVE - FEMALE X FEMALE

- Brass body and plated finish
- For isolating part of the system, this avoids the need to drain down the whole system in order to carry out repairs.
- For cold water
- Manufactured from high quality materials
- Female x Female

Size	Code
1/2"	364902
3/4"	364903

Plumbing Brassware & Accessories // Valves 9



Lever Ballvalve Compression

BLUE BUTTERFLY HANDLE LEVER BALLVALVE

- Brass body and plated finish
- Compression x Compression
- For isolating part of the system, this avoids the need to drain down the whole system in order to carry out repairs.
- For cold water
- Manufactured from high quality materials

Size	Code
15mm	364892
22mm	364893



Lever Ballvalve Female x Female

BLUE HANDLE LEVER BALLVALVE - FEMALE X FEMALE

- Brass body and plated finish
- For isolating part of the system, this avoids the need to drain down the whole system in order to carry out repairs.
- For cold water
- Manufactured from high quality materials
- Female x Female

Size	Code
1/4"	364894
3/8"	364895
1/2"	364896
3/4"	364897
1"	364898
1 1/4"	364899
1 1/2"	364900
2"	364901



Lever Ballvalve Female x Female

FEMALE X FEMALE GAS LEVER BALLVALVE. YELLOW HANDLE.

- Brass body and plated finish
- Female x Female
- For isolating part of the system, this avoids the need to drain down the whole system in order to carry out repairs
- For gas
- Manufactured from high quality materials

Size	Code
1/2"	332976
3/4"	332977
1"	332980
1 1/4"	364189
1 1/2"	364190
2"	364191



Lever Ballvalve Compression

COMPRESSION LEVER BALL VALVE. YELLOW HANDLE.

- Brass body and plated finish
- Compression x Compression
- For isolating part of the system, this avoids the need to drain down the whole system in order to carry out repairs.
- For gas
- Manufactured from high quality materials

Size	Code
15mm	364925
22mm	364926
28mm	364927
35mm	364928
42mm	364929
54mm	364930



Y Strainer

COMPRESSION Y STRAINER

- Compression Y Strainer - Typically used in systems where basic filtration is needed to protect downstream equipment from damage caused by debris
- 15mm in-line isolating valve
- Double check valve
- Integral removable strainer
- 40 Mesh
- Supplied with both red & blue handles
- 180° rotation
- Suitable for copper & plastic pipe

Size	Code
15mm Compression	364117
15mm Compression with Double Check Valve, 40 mesh	364116

9 Plumbing Brassware & Accessories // Valves



CxC Gate Valve

BRASS COMPRESSION X COMPRESSION GATE VALVES

- Water flow can be easily adjusted manually without any need for tools
- For isolating part of the system, this avoids the need to drain down the whole system in order to carry out repairs.
- Manufactured from high quality materials

Size	Code
15mm	363990
22mm	363991
28mm	363992



Lockshield Gate Valve

BRASS LOCKSHIELD GATE VALVE

- For isolating part of the system, this avoids the need to drain down the whole system in order to carry out repairs.
- Manufactured from high quality materials

Size	Code
15mm	363993
22mm	363994



British Standard Gate Valve

BRASS GATE VALVE MADE TO BRITISH STANDARD BS5154

- Water flow can be easily adjusted manually without any need for tools
- Manufactured to British Standard BS5154
- For isolating part of the system, this avoids the need to drain down the whole system in order to carry out repairs.
- Manufactured from high quality materials

Size	Code
15mm	364089
22mm	364090
28mm	364091
35mm	364104
42mm	364105
54mm	364106



Lockshield British Standard Gate Valve

BRASS LOCKSHIELD GATE VALVE MADE TO BRITISH STANDARD BS5154

- Manufactured to British Standard BS5154
- For isolating part of the system, this avoids the need to drain down the whole system in order to carry out repairs.
- Manufactured from high quality materials

Size	Code
15mm	364092
22mm	364093
28mm	364094



FxF Gate Valve

BRASS FEMALE X FEMALE GATE VALVE

- Water flow can be easily adjusted manually without any need for tools
- For isolating part of the system, this avoids the need to drain down the whole system in order to carry out repairs.
- Manufactured from high quality materials

Size	Code
½"	364095
¾"	364097
1"	364099
1¼"	364101
1½"	364102
2"	364103

Plumbing Brassware & Accessories // Valves 9



CxC Stopcock

COMPRESSION X COMPRESSION STOPCOCK

- For isolating part of the system, this avoids the need to drain down the whole system in order to carry out repairs.
- Manufactured from high quality materials
- Compression x Compression BS1010

Size	Code
C x C Stopcock - 15mm	363995
C x C Stopcock - 22mm	363996
C x C Stopcock - 28mm	363997
C x C Stopcock - 15mm Bronze	364001
C x C Stopcock - 35mm DZR	364218
C x C Stopcock - 42mm DZR	364219
C x C Stopcock - 54mm DZR	364220



Compression x Poly Stopcock

CONFORM TO THE BS1010 STANDARD

- Compression x Poly
- For isolating part of the system, this avoids the need to drain down the whole system in order to carry out repairs.
- Manufactured from high quality materials
- For connecting copper to MDPE pipe

Size	Code
Compression x Poly Stopcock - 25mm x 25mm	363998
Compression x Poly Stopcock - 15mm x 25mm	363999
Compression x Poly Stopcock - 15mm x 20mm	364000
Compression x Poly Stopcock - 20mm x 20mm	364003
Compression x Poly Stopcock - 22mm x 25mm	364004



Female x Female Stopcock

FEMALE X FEMALE STOPCOCK. VARIOUS SIZES.

- Female x Female
- For isolating part of the system, this avoids the need to drain down the whole system in order to carry out repairs.
- Manufactured from high quality materials

Size	Code
½"	364107
¾"	364109



Stopcock Drain Off

15MM STOPCOCK DRAIN OFF

- Supplied with drain off
- For isolating part of the system, this avoids the need to drain down the whole system in order to carry out repairs.
- Manufactured from high quality materials
- 15mm Stopcock Drain Off

Item	Code
Stopcock Drain Off	364034



Lead Free Checkvalve

LEAD FREE 15mm DOUBLE CHECK VALVE

- Lead Free
- 15mm Double Check Valve

Size	Code
15mm Checkvalve	364206

9 Plumbing Brassware & Accessories // Flexible Tap Connectors



Flexible Tap Connector FxC STANDARD AND FULL BORE

- Stainless Steel Braided over EPDM rubber – 10 bar tested
- Manufactured from high quality materials
- Female x Compression
- Standard and Full Bore available
- Standard Bore Type WRAS approved

Size	Bore Size	Code
Standard Bore Type		
15mm x 1/2" x 300mm	9mm	368965
15mm x 1/2" x 500mm	9mm	368970
15mm x 1/2" x 900mm	9mm	368973
15mm x 3/4" x 300mm	9mm	368960
15mm x 3/4" x 500mm	9mm	368990
15mm x 3/4" x 900mm	9mm	368991
15mm x 3/8" x 300mm	9mm	368979
22mm x 3/4" x 300mm	13mm	368980
22mm x 3/4" x 500mm	13mm	368982
22mm x 3/4" x 900mm	13mm	368984

Full Bore Type		
15mm x 1/2" x 300mm	13mm	368974
15mm x 3/4" x 300mm	13mm	368992
15mm x 1/2" x 500mm	13mm	368971
22mm x 3/4" x 300mm	19mm	368985
Standard Bore Type WRAS Approved		
15mm x 1/2" x 300mm	9mm	368978
22mm x 3/4" x 300mm	13mm	368989
15mm x 3/4" x 300mm	9mm	369000



Pushfit Flexible Tap Connector STANDARD AND FULL BORE

- Stainless Steel Braided over EPDM rubber – 10 bar tested
- Manufactured from high quality materials
- Push fit – simple to install

Size	Bore Size	Code
Standard Bore Type		
15mm x 1/2" x 150mm	9mm	368977
15mm x 1/2" x 300mm	9mm	368976
15mm x 1/2" x 500mm	9mm	368972
15mm x 3/4" x 300mm	9mm	368999
22mm x 3/4" x 300mm	13mm	368988
22mm x 3/4" x 500mm	13mm	368983
Standard Bore Type with Isolation Valve		
15mm x 1/2" x 300mm	9mm	368975
22mm x 3/4" x 300mm	13mm	368987
Standard Bore Type with Push Fit Both Ends		
15mm x 15mm x 300mm	9mm	368969



Flexible Tap Connector with Isolation Valve STANDARD AND FULL BORE

- Stainless Steel Braided over EPDM rubber – 10 bar tested
- Manufactured from high quality materials
- Supplied with isolation valve
- Standard and Full Bore available
- Standard Bore Type WRAS approved

Size	Bore Size	Code
Standard Bore Type		
15mm x 1/2" x 300mm	9mm	368961
15mm x 1/2" x 500mm	9mm	368962
22mm x 3/4" x 300mm	13mm	368986
Full Bore Type		
15mm x 1/2" x 300mm	13mm	368963
Standard Bore Type WRAS Approved		
15mm x 1/2" x 300mm	9mm	368964



Flexible Tap Connector COMPRESSION X COMPRESSION STANDARD AND FULL BORE

- Stainless Steel Braided over EPDM rubber – 10 bar tested
- Manufactured from high quality materials
- Compression x Compression
- Standard and Full Bore

Size	Bore Size	Code
Standard Bore Type		
15mm x 15mm x 300mm	9mm	368966
22mm x 22mm x 300mm	13mm	368981
Full Bore Type		
15mm x 15mm x 300mm	13mm	368968



Flexible Tap FxF Connector FEMALE X FEMALE FLEXIBLE TAP CONNECTOR

- 1/2" x 1/2" x 300mm – 9mm Bore
- Stainless Steel Braided over EPDM rubber – 10 bar tested
- Manufactured from high quality materials
- Female x Female

Size	Bore Size	Code
1/2" x 1/2" x 300mm	9mm	368996



Monobloc Flexible Tap Connectors (K) FLEXIBLE TAP CONNECTORS

- Stainless Steel Braided over EPDM rubber – 10 bar tested
- Supplied in pairs
- Manufactured from high quality materials

Size	Bore Size	Code
M10 x 15mm x 300mm	8mm	368997
M12 x 15mm x 300mm	8mm	368998

Water Hammer Arrestors 10



MINI RESTER

PIPES VALVES & FITTINGS // WATER HAMMER ARRESTORS Sioux Chief 1/2" Mini Rester

- Arrestors should be installed within six feet of the problem valve/tap
- May be installed at any angle
- Mini Resters with a male 1/2" thread are simply fitted with Female 1/2" x 15mm Iron Tee
- Mini Resters with a Hose Tee Connection install directly on Washing Machine Supply Valves or directly to Washing Machines
- Designed for residential use and for single application installation

Size	Code
1/2" BSP Mini Rester	367065



MINI RESTER WASHING MACHINE FITTING

PIPES VALVES & FITTINGS // WATER HAMMER ARRESTORS Sioux Chief 1/2" Washing Machine/Dishwasher Fitting

- Arrestors should be installed within six feet of the problem valve/tap
- May be installed at any angle
- Mini Resters with a male 1/2" thread are simply fitted with Female 1/2" x 15mm Iron Tee
- Mini Resters with a Hose Tee Connection install directly on Washing Machine Supply Valves or directly to Washing Machines
- Designed for residential use and single application installation

Size	Code
3/4" BSP Mini Rester Washing Machine Fitting	367068



HYDRA RESTER

PIPES VALVES & FITTINGS // WATER HAMMER ARRESTORS Sioux Chief Hydra Rester For Multi Appliance Installation

- Arrestors should be installed within six feet of the problem valve/tap and may be installed at any angle
- Mini Resters with a Male 1/2" thread are fitted with Female 1/2" x 15mm Iron Tee
- Mini Resters with a Hose Tee Connection install directly on Washing Machine Supply Valves or directly to Washing Machines
- Designed for residential use and multiple application installation

Type	Size (L x W)	Code	Type	Size (L x W)	Code
1/2" BSP Threaded	6.1/2" x 1.3/8"	367059	1" BSP Threaded	10.1/8" x 2.1/8"	367062
3/4" BSP Threaded	8.3/4" x 1.3/8"	367060	1" BSP Threaded	12.1/8" x 2.1/8"	367063
1" BSP Threaded	11" x 1.3/8"	367061	1" BSP Threaded	15.1/8" x 2.1/8"	367064

Spares

If you are in need of high-quality replacement parts you will find exactly what you are looking for within our spares and accessories section. We have spares for our Toilet Cisterns, Syphons, Electroflo and Kinetic ranges as well as Hydroflo and Ballvalve spares.

All our spares and accessories are made to exacting standards and undergo a range of quality tests and checks prior to despatch.

Dudley 

Epson 

Beta 



In this section

- 01 » Toilet Seat Spares & Accessories
- 02 » Electroflo Spares & Accessories
- 03 » Kinetic Spares & Accessories
- 04 » Syphon Spares & Accessories
- 05 » Flush Valve Spares & Accessories
- 06 » Hydroflo Inlet Float Valve Spares & Accessories
- 07 » PVC Flushbends & Flushpipes Spares & Accessories
- 08 » Ballvalve & General Parts
- 09 » Toilet Cistern Spares



Visit our website

Visit our website and search our extensive range of plumbing parts, find key product information such as technical specifications, installation and troubleshooting guides and create your order all in one place using our Quote Builder function.

Spares

01. Toilet Seat Spares & Accessories

Code	Product Name	Description
320910	Toilet Seat Hinge	C25 Easy Fit Plastic Toilet Seat Hinge for Epon Toilet Seats
320911	Toilet Seat Hinge	C30 Easy Fit Stainless Steel Toilet Seat Hinge for Epon Toilet Seats
320912	Toilet Seat Hinge	C31 Easy Fit Stainless Steel Toilet Seat Hinge for Epon Toilet Seats
320913	Toilet Seat Hinge	C33 Top Fix Easy Fit Stainless Steel Toilet Seat Hinge for Epon Toilet Seats
323745	Toilet Seat Hinge	Top Fix Hinge for Rhianna and Esme Soft Close Toilet Seat

02. Electroflo Spares & Accessories

Code	Product Name	Description
323694	Battery Box	IP67 Battery Box for Battery Operated Dudley Electroflo Taps (Except Contemporary)
323692	Power Splitter	Two Way Power Splitter (M-F2) 100mm (For use with Contemporary Taps)
324324	Power Splitter	Two Way Power Splitter (F-M2) 100mm
324325	Power Splitter	Three Way Power Splitter (F-M3) 100mm
326398	Cable Extension	3 Metre Cable Extension for Electroflo Taps, Urinals and Soap Dispensers (RED)
326998	Solenoid Valve	Solenoid Valve Spare, for Dudley Electroflo Taps and Urinal Sensor. (Includes Diaphragm)
333866	Diaphragm	Diaphragm only for Solenoid Valve for Dudley Electroflo Taps. 10 Pack

Electroflo WC flush Spares & Accessories

Code	Product Name	Description
325443	Junction Box	Transformer Junction Box for Dudley 'Electroflo' Cisterns (Suitable for up to 10 Cisterns)
324468	Electroflo Control Box & Sensor	Electroflo Control Box & Sensor only
324469	CP Single Flush	100mm Surround only Dudley 'Electroflo'
324470	CP Dualflush	100mm Surround only Dudley 'Electroflo'
325270	Electroflo Extension Lead	500mm Extension Lead
325894	Infrared Sensor Eye	Infrared Sensor Eye with Cable for Dudley 'Electroflo' Cistern
326647	Electroflo Control Box	Electroflo Control Box only
329984	Dudley 'Electroflo' Sensor	Satin Stainless Steel Surround, Sensor, 304G
323107	Mains Adaptor Dudley 'Electroflo' Cistern	Mains Adaptor Dudley 'Electroflo' Cistern
324217	Wall Extension kit	125mm Wall Extension kit for WC Electroflo Sensor

03. Kinetic Spares & Accessories

Code	Product Name	Description
330349	Servicing Kit	Kinetic Servicing Kit
330350	Kinetic Solenoid Valve	White
330351	Kinetic Solenoid Valve	Grey
330353	Kinetic Front Panel	White

Dudley Spares

04. Dudley Syphon Spares & Accessories

Code	Description
372687	Universal Syphon Toilet Repair Kit Including: Turbo Edge Adjustable Syphon, Hydroflo Telescopic Compact Float Valve & Cistern Lever
313313	Dudley Syvac Syphonic Aspirator (For S7 and Turbo 88 only)
316855	Plastic Piston with Polythene Diaphragm for Turbo 88 Syphon
319797	Plastic Piston with Polythene Diaphragm for Turbo S1-11 Syphon
314837	1½" Plastic Backnut
316571	1½" Capnut
318134	Stainless Steel 'C' Link - Up To 76mm [3"]
317307	Stainless Steel 'C' Link - 3.½"
317898	Stainless Steel 'C' Link - 3.¾"
317143	Stainless Steel 'C' Link - 4"
322946	Stainless Steel 'C' Link - 4.¼"
318323	Stainless Steel 'C' Link - 4.½"
317537	Stainless Steel 'C' Link - 5.½"
313245	Polythene Syphon Diaphragm to suit Turbo 88 / S7 Cascade
314095	Polythene Syphon Diaphragm to suit S9, Hi-Flo / Japtic
316576	Polythene Syphon Diaphragm to suit Turbo S1-11
319228	Spares Pack for Dudley Turbo 88 2-Part Syphon
315716	Spares Pack for Dudley Turbo S1-11 2-Part Syphon
318665	Spares Pack for Dudley Turbo S44-R 2-Part Syphon
320494	6/7L White Plug for Turbo 88 Syphon
315267	Natural Plastic Bung for Turbo 88 Syphon
370213	38.42mm ID Coupling Nut
367465	2" Syphon Washer Rubber
367466	1.1/2" Rubber Washer for Syphon Tail
367467	1.1/4" Rubber Washer for Syphon Tail
367468	1" Rubber Washer for Syphon Tail
367473	120mm Round Diaphragm Washer (4.1/2")
316068	203mm Dudley Turbo S44-R2-Part Syphon.
314642	Dudley 216mm Turbo 88 2-Part Singleflush Syphon
318729	83mm 'C' Link (3.1/4")
319211	Domed Rubber Washer For Syvac Syphonic Aspirator
371155	Spares Pack for Dudley Turbo Edge® Compact Syphon
367476	Diaphragm Washer to Suit Turbo 44 Syphon
367477	130mm Round Diaphragm Washer (5")

05. Dudley Flush Valve Spares & Accessories

Code	Description
372686	Universal Flush Valve Repair Kit Including: Victoria Dualflush Valve, Hydroflo Telescopic Compact Float Valve, Cistern to Pan Close Coupled Nut, Bolt & Washer Set & Close Coupling Kit Including Washer
318082	1½" Adaptor (Reducer) Suitable for Niagara Mechanical Valve
315900	Push Rods for Niagara Mechanical Valve
325691	Dudley 'Victoria' Dualflush Cable Operated Valve, Chrome Plated Dual Flush Button, 2" Outlet with 470mm Cable Length and 68mm Diameter Back Nut
325972	2" Outlet Cage and 'O' Rings
326900	1.½" White Outlet Cage, 40mm Tail, Overflow Pipe & Nut, Backnut, Capnut, Cone Ring & 1.½" Outlet Washer
316129	Dudley "Pinto" Pneumatic Single Flush Valve. 2" Outlet. Air Tube & Outer Protective Corrugated Sleeve. 6 Litre.
315297	Rubber Valve Sealing Washer For Dudley Pinto Valve (60x 24x 3mm) Grey
318948	75 x 58 x 4mm Rubber Outlet Washer For Dudley Pinto Valve Outlet
323306	Stepped Rubber Valve Sealing Washer Dudley Niagara Valve (65x 37x 4mm)
314574	Rubber Valve Sealing Washer For Niagara Mechanical Valve 38mm [I.D.]
323768	Clear Bellows for Dudley Niagara Pneumatic Valve
318947	Bellows for Dudley Pinto Valve
318289	Rubber Outlet Washer For Niagara Valve Outlet
315604	2" Backnut
314962	Black 51mm i.d. Tapered Cone Ring (2")
319678	2" Capnut

Dudley Spares

06. Hydroflo Inlet Float Valve Spares & Accessories

Code	Description
317158	Filter and 'O' Ring
313299	Filter Key
317673	Rubber Washer [37.5mm O.D.]
317733	Float
318949	Float Arm and Pressure Chamber Cover
327211	Compact Delay Fill Float Arm and Pressure Chamber Cover
318756	White Flow Restrictor
315067	Blue Flow Restrictor
319726	Black Rubber Diaphragm Washer c/w blue pin for standard Hydroflo
316295	½" Backnut
316999	Overhead Discharge Nozzle Assembly (Divertor including silence tube)

07. PVC Flushbends & Flushpipes Spares & Accessories

Code	Description
315587	1676mm x 45mm White 3-Piece PVC Side Wall Flushpipe
318054	Flow Restrictor for high level flush pipe (Baffle)
370220	Finned Push-In WC Pan Connector
319415	356mm x 229mm x 38mm White Flushbend & Ring
322326	Tapered White Flushbend 51mm to 41mm
323782	457mm x 457mm Tapered Flushbend (Europipe) 45.75mm I.D. to 41.35mm O.D.
315841	38mm [1.½"] I.D. Tapered Cone Ring
315432	32mm [1.¼"] I.D. Tapered Cone Ring
316721	Slip Ring (Yellow) 51mm to 41mm Flushbend
363710	Standard European Flushbend 50mm (2") to 41mm (1.½") DIA. 230 X 210mm
327598	Natural 51mm i.d. Tapered Cone Ring (2")
315480	1676x32mm 4-Pce PVC B'Wall F'Pipe White. H/L Cone Ring (5'6"x 1.¼")
321958	Rubber Flushbend Connector 60mm 2" Reducing Flushbend
317684	610mm x 457mm x 38mm White Flushbend & Ring

08. Ballvalves & General Parts

Code	Description
316574	32mm Diameter Diaphragm
317820	114mm [4.½"] Blue Round "Qualifloat" Plastic Float
317501	114mm [4.½"] Elongated Plastic Float
316308	Plastic Pedestal Overflow Comes With Nuts & Washer
367963	32mm BV. DIAPHRAGM WASHER (1.¼")
316467	Rubber Washer for Thread of Pedestal Ballvalve
370224	32mm BV. Diaphragm Washer (1.¼")

09. Vantage Toilet Cisterns Spares

Code	Description
313748	Blue Access Top Cover for Dudley 'Vantage' Cistern
323579	Blue Access Front Cover for Dudley Vantage 2 Cistern to include Air Tube Connectors
326095	"Dudley 'Electroflo' Dual Flush for 'Vantage 2' & 'Miniflo' Cistern control box and sensor, 'Niagara' DF Pneumatic Valve, CP 100mm & 40mm Surround Sensor, Battery Operated"
326096	"Dudley 'Electroflo' Dual Flush for 'Vantage 2' & 'Miniflo' Cistern control box and sensor, 'Niagara' DF Pneumatic Valve, CP 100mm & 40mm Surround Sensor, Mains Operated"
325570	Wall Clamp & Fixing Clip Dudley 'Vantage 2' Cistern
326243	Volume Baffle/Partition Dudley 'Vantage 2'
329580	Braided Hose & Isolating Valve t/s Dudley 'Vantage 2' Cistern (Overall Length 270mm) with Black Bulk Head
317532	Speedfit Inlet Elbow
318634	Vantage Pneumatic Tube (Green) (750mm)
319059	Vantage Pneumatic Tube (Clear) (750mm)

Dudley Spares

OBC/Prestige Toilet Cisterns Spares

Code	Description
325087	Braided Hose & Isolating Valve t/s Dudley 'OBC/Prestige' Cistern (Overall Length 215mm) with White Bulk Head

Toilet Cistern Levers and Spares

Code	Description
316786	Windsor Flush Lever Assembly, Chrome Plated. 80mm Spindle, Camel Adjustable Lift Arm
317072	Windsor Flush Lever Assembly. Chrome Plated. 140mm Spindle, Camel Adjustable Lift Arm
318090	Front Fit Kit W. Chrome Plated
318659	Windsor Flush Lever Assembly. Chrome Plated. 110mm Spindle, Camel Adjustable Lift Arm
319732	Concealed Kit W. Chrome Plated
315881	Plastic Flush Lever Assembly. Chrome Plated. 120mm Spindle, Camel Adjustable Lift Arm
316549	Plastic Flush Lever Assembly. Chrome Plated
313907	White Plastic Flush Lever Assembly
326866	CP 100mm Surround only Dio, Royal & Miniflo Buttons
319042	Plastic Front Lever Assembly Chrome Plated. 100mm Spindle, Green Lift Arm
313126	HL Fulcrum Bracket & Screw for Tri-Shell/Aclaim/Mirage/Diplomat/Tri-Well Levers
313301	140mm Metal Lever (5.½")
313942	Green Plastic Lift Arm
315056	Concealed H/L Adaptor Kit
318166	Red Plastic Lift Arm
318671	Push Knob Pin & Cotter Pin
318741	170mm P2/P3 Lever Linkage
318851	125mm P2/P3 Lever Linkage for Dudley Cistern
316437	'Windsor' Flush Lever Chrome Plated 120mm Spindle, Camel Adjustable Lift Arm.
313964	Concealed Kit A. Chrome Plated.
313149	Concealed Kit B. Chrome Plated.
318138	Dimple (B) PH Lever Kit B Assembly. Chrome Plated. Camel Adjustable Lift Arm
318252	Dimple (A) PH Lever Kit A (311mm) Assembly. Chrome Plated. Adjustable Lift Arm
315194	Nylon Cord & Plastic Pull
314065	Plated Chain & Plastic Pull

Toilet Cisterns Spares

Code	Description
319249	¾" Blanking Off Plug Comes With Backnut & Washer
368051	Overflow Washer
314241	Close Coupling Kit (Oval Hole) c/w 95x 70x 12.5mm Sealing Washer
317093	Screw For Cistern Lid White (18.5mm)
331610	Access Tunnel for Dudley Flush Plate
314063	Screw for Cistern Plastic Lid (31.5mm)
316218	Screw For Cistern Plastic Lid. White (23.5mm)

Dudley Push Button and spares

Code	Description
318767	Concealed Kit P. Chrome Plated
323280	Dudley Stainless Steel Extended 'Royal' Push Button Assembly with 160mm Long Plastic Threaded Bush
323705	Dudley CP Extended 'Royal' Single Flush Push Button with 260mm Long Plastic Threaded Bush
333926	Pack of 2 Dudley Chrome Plated 'Royal' Push Buttons
322250	"225mm Long Dudley Metal Flat Vandal Resistant Button Assembly to suit Dudley 'Pinto' Flush Valve Suitable for 150mm Thick Wall"
326377	CP 51mm Surround only Dio, Royal & Miniflo Buttons

Dudley Spares

Minflo Cistern Spares

Code	Description
323923	Hanging Bracket for Dudley 'Miniflo' Cistern
324371	Volume Baffle/Partition Dudley 'Miniflo' (white)

Diplomat Cistern Spares

315643	Diplomat HL 130mm Plastic Lever (5")
318806	Diplomat HL/Acclaim HL 140mm Plastic Lever (5½")

Tri-Shell Cistern Spares

Code	Description
314614	Tri-Shell HL 152mm Metal Lever (6")
317814	Tri-Shell Metal Front Lever Assembly. Chrome Plated. Pink Lift Arm
320963	Tri-Well HL 108mm Metal Lever

Elite Cistern Spares

Code	Description
313604	Push Knob for Elite. Chrome Plated

Slimline Cistern Spares

Code	Description
314926	H/L Conversion Kit for Slimline (to include Lever, Chain, Pull, Medallion, 3-pce Flushpipe)

Terms & Conditions of Sale

For full terms and conditions of sale please visit our website



WRAS / UKAS

Thomas Dudley tests its products in our own WRAS recognised / UKAS accredited test laboratory



Thomas Dudley is proud to support Made in Britain

For more information please visit the Made in Britain Website



Committed to the Environment

Thomas Dudley has a commitment to comply with all relevant Environmental Policies, associated statutory legislation and approved codes of practice. For more information please visit our website



When Quality & Commitment Counts

Thomas Dudley is committed to manufacturing high quality products that are both innovative and extremely reliable. We hold a number of accreditations including ISO 9001, ISO14001 and OHSAS18001



Index

A

Adjustable Syphons	44
Air Vents and Keys	173
Auto Cisterns	53
Auto Syphons	47

B

Backplates	168
Bailey Products	154-163
Ball Floats	144
Ballvalve Diaphragm Washers	124
Ballvalves	138
Ballvalve Seating and Pistons	142
Ballvalve Repair Kit	123
Ballvalve Washers	123
Basin (Resan)	68
Basin [oval] Hanger Bracket	73
Basin Wastes	81
Basin Wastes with Basin Mate	77
Basin Waste Seal Kit	76
Basket Strainer Waste	89
Bathroom Accessories	76
Bath & Basin Chains	108
Bath Grips	105
Bath Overflow Stoppers	106
Bath Wastes	84
Beta+ Inlet Valves	38
Beta Range	137
Boss Jointing Compound	153
Bottle Traps	92
Brackets (Frame)	33
Brass Float Valves	138
Brass Pipe Fittings	144
Brass Olives	148
Bushes	150
Buttons & Pushplates	22

C

Cascade+	45
C-Links	118
Catering Hoses	165
Ceramic Tap Glands	103
Chains (Basin & Bath)	108
Checkvalves	178
Chrome Pipe Fittings	149
Cisterns	48
Cistern and Tank Fittings	118
Cistern Hole Stoppers	106
Cistern Levers	109

Cistern Pulls	116
Close Coupling Kits	121
Close Coupling Kit Washers	121
Combi Filling Loop	174
Compression Fittings	145
Concealed Cisterns	48
Consumables	153
Cooker Hoses	165
Cooker Stability Chain	165
Copper Float	143
Copper Olives	148
Copper Saddle Clips	167
Cotter Pins	141
Coupling Nuts	118

D

DC Pipe Interrupter	118
Diaphragm Washer	118/124
Disabled (Dimple) Levers	111
Drain Equipment	154
Drain Cleaning Brushes	158
Drain Test Plug	162
Drain Rods and Tools	154
Drain Trace Dye	159
Draincocks	174
Drop Arm & Adaptor	140
Dualflush Buttons	24
Dual Purpose Clips	168
DZR Hose Union	179
Dudley Range	21

E

eco-cistem™	16/48
Electroflo Soap Dispensers	59
Electroflo Taps	58
Electroflo Urinal Sensor	63
Electroflo WC Sensor	63
Epson Range	75
Equilibrium Float Valve	143
Europipe	119
Exposed Cisterns	52

F

Fixing Kits (Sanitary)	104
Flat Tap Washers	131
Flexible Rubber Fittings	169
Flexible Tap Connectors	184
Floats (Plastic)	144

Floats (Copper)	143
Float Operated Valve	140
Flush Grated Waste	87
Flushing (Outlet) Valves	40
Flushpipe Connectors	120
Flushpipes	119
Flux	153
Force Cup (Plunger)	156
Frames	30

G

Gas Cocks	164
Gas Fibre Washers	165
Gas Products	164
Gas Tape (PTFE)	153
Gas Washers	165
Gatevalves	182
Geka Fittings	152
Grab / Support Rails	105

H

High Level Cistern Lever	117
Hinges (Toilet)	101
Hose Clips	166
Hose Union Bibcocks	179
Hose Washer	135
Hospital Brackets	168
Hydrant Standpipe & Keys	158
Hydra Rester	185
Hydroflo Inlet Valves	35

I

Immersion Heater Plugs	175
Inflator Bags	159
Inflator Pumps	159
Inlet Hose Connector	176
Inlet Valve Accessories	129
Inlet Valves	35
Isolating Valves	177

J

Jointing Compound	153
-------------------	-----

K

Kinetic Range	62
Kinetic Urinal Flush Control	62
Kitchen Accessories	76

Index

L

Lever Ballvalves	180
Lever Ballvalves [gas]	165
Levers	109
Lift Arms	117

M

MDPE Fittings	183
Metal Flushpipes & Accessories	119
Meter Box Keys	165
Mini Gas Ballvalves	164
Mirror (Resan)	69
Munsen Rings	167
Mini Rester	185

N

Niagara Range	41
Nuts	118

O

O Rings	123/124/135
Olives	148
Osmo F1	51
Osmo T1	51
Outdoor Tap Kits	179
Outlet Hose Connector	176
Outlet Valves	40
Overflows	122
Overflow Stopper	106

P

P Traps	91
Pans (Resan)	65
Pan Connectors	94
Petcock	118
Pipe Clips	166
Pipe Cutters	153
Pipe Fittings	145
Pipes, Valves and Fittings	137
Plastic Ball Floats	144
Plugs	106
Plumber boxes	123
Plumbing Fittings & Spares	75
Plunger	156
Poly Bag Range	128
Poly Washers	132
Pre Packed Products	123
PTFE Tape	153
Pump Gasket	175
Pump Union	175

Pump Valve	175
Pulls (Cistern)	116
Push Plates	28

Q

Quantum	18/43
---------	-------

R

Radiator & Heating Products	171
Radiator Brackets	172
Radiator Keys	172
Radiator Valves	171
Repair Kits	39/41
Resan Range	65
Rubber Lined Clips	168----

S

S Traps	91
Saddle Clips	167
Sanitaryware (Resan)	65
Sanitary Fixing Kits	104
School Board Clips	167
Service Valves	177/178
Shelf (Resan)	69
Shower Curtain	103
Shower Hoses	103
Singleflush Pushbuttons	25
Sink Overflow Stoppers	106
Sink Strainers	89
Sink Waste	88
Smoke Testers	157
Soap Dispenser	59
Socket	72/164
Solder	153
Sparge Pipe Sets	118
Spreaders	118
Spring Safety Valves	175
Stopcocks	183
Stopcock Key	158
Stoppers	106
Support Rail	105
Syphon Accessories	118
Syphon Washers	118
Syphons	42
Syvac Aspirator	130

T

Tap Extension	151
Tap Glands	103
Tap Hole Stoppers	106

Tap Swops	102
Tap Washers	131
Telecoms Ducts Rods	161
Test Kits (Drains)	159
Test Plugs	162
Threaded Pipe Fittings	150
Toilet Cisterns	48
Toilet Roll Holders	102
Toilet Roll Holder Inserts	102
Toilet Seats	100
Toilet Seats Hinges	101
Top Hat Washers	131
Touch Free	58
Traps	91
Turbo Edge	44
Turbo Edge Quantum	18/42
Turbo 88	44

U

Urinal Accessories	118
Urinal Brackets	104
Urinal (Resan)	69
Urinal Flush Controls	62
Urinal Pipework	118
Urinal Sensors	63
Urinal Spreaders	118
Urinal Waste	90

V

Valves (brassware)	177
Valves (Inlet)	35
Valves (Outlet)	40
Vantage	50

W

Wallplate Connector	178
Washers and Seals	131
Washing Machine Hoses	176
Washing Machine Taps	176
Washroom Control System	70
Washroom Fill and Flush	21
Waste Connectors	90
Wastes, Traps & Accessories	76
Water Hammer Arrestors	185
Wave Touch Free Range	22
Whats New	18

Y

Y Adaptor	176
Y Strainer	170/181

T H O M A S
D U D L E Y



The Plumbers Choice **Built for Plumbers. Built for Britain.**



BDM SCOTLAND & IRELAND

m +44 (0) 7803 236 049

BDM NORTH

m +44 (0) 7703 193 370

BDM - CENTRAL

m +44 (0) 7508 442 672

BDM SOUTH EAST

m +44 (0) 07712 842 787

BDM SOUTH WEST

m +44 (0) 7711 800 166

SPECIFICATION SALES MANAGER

m +44 (0) 7717 200 699

PUBLIC SECTOR NORTH

m +44 (0) 7747 446 146

PUBLIC SECTOR SOUTH

m +44 (0) 7803 890 796

PRIVATE SECTOR NORTH

m +44 (0) 07468 474 245

PRIVATE SECTOR SOUTH

m +44 (0) 7867 170 142

UK ENQUIRIES

t +44 (0)121 530 7000

or e sales@thomasdudley.co.uk



PSPSPL373014